

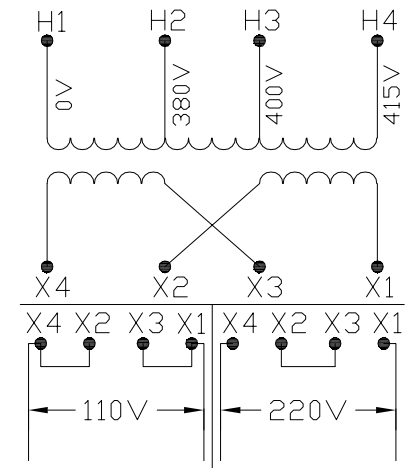

TRANSFORMER SPECIFICATIONS	
PRIMARY VOLTAGE(S)	380/400/415
SECONDARY VOLTAGE(S)	110x220
RATED V.A.	150
RATED FREQUENCY	50/60
INSULATION CLASS	130°C @ MAX RISE 80°C
AGENCY APPROVALS	UL, CUL
ESTIMATED WEIGHT	6.7 LBS

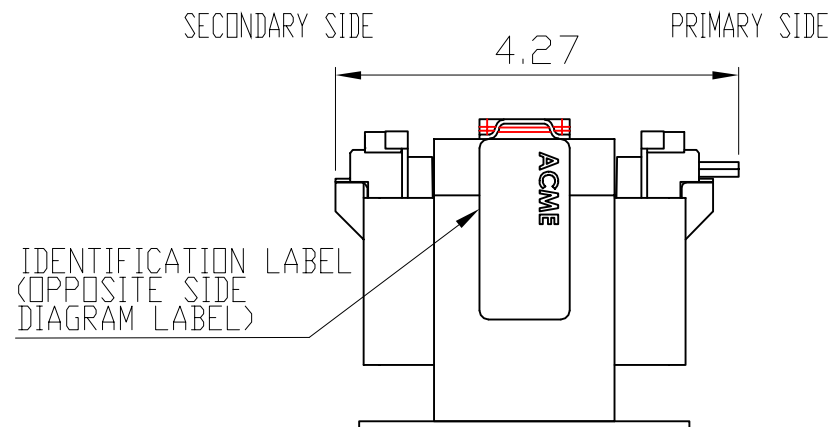
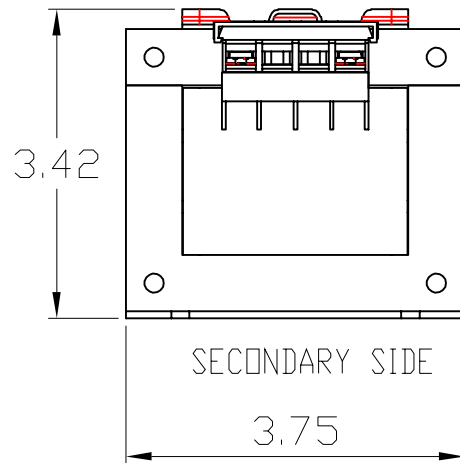

CONNECTION DIAGRAM

DIMENSIONS ARE IN INCHES TOLERANCES: .XX ± .03 .XXX ± .010 ANGULAR: ± 1°	DRAWN BY:	VS	DATE	06/05/2020	 DESCRIPTION: 150 VA
	CHECKED BY:				
SOURCE	N/A				PROPRIETARY AND CONFIDENTIAL THE INFORMATION CONTAINED IN THIS DRAWING IS THE SOLE PROPERTY OF ACME ELECTRIC. ANY REPRODUCTION IN PART OR AS A WHOLE WITHOUT THE WRITTEN PERMISSION OF ACME ELECTRIC IS PROHIBITED.
MATERIAL	N/A				
FINISH	N/A				
DO NOT SCALE DRAWING	SIZE	DWG. NO.		A	CE150N016
	WEIGHT:	LBS.			SHEET 1 OF 1