

TOP KO DIMENSIONS ARE IDENTICAL TO BOTTOM KO DIMENSIONS

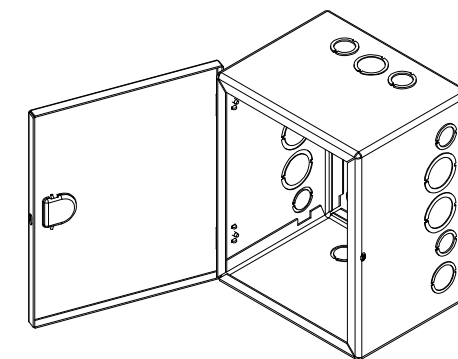

8-32X3/8" TRUSS HEAD SCREW AND HINGE CLIP (2 PL.)

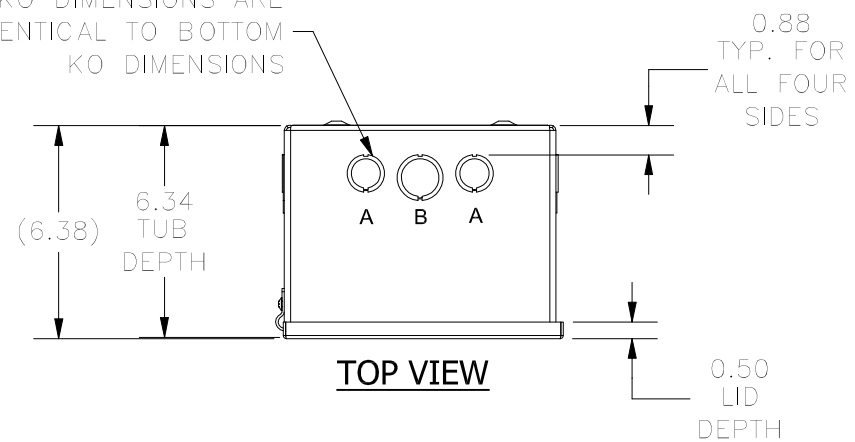
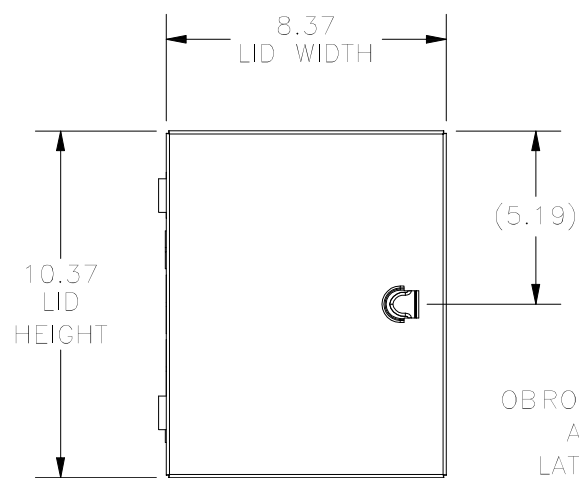
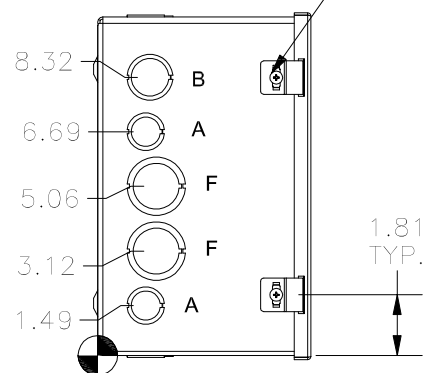

RIGHT SIDE KO DIMENSIONS ARE IDENTICAL TO LEFT SIDE KO DIMENSIONS

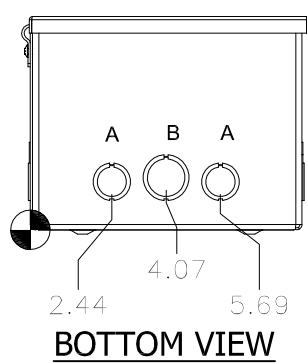
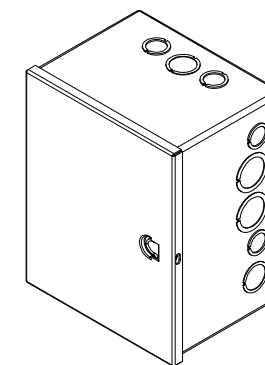
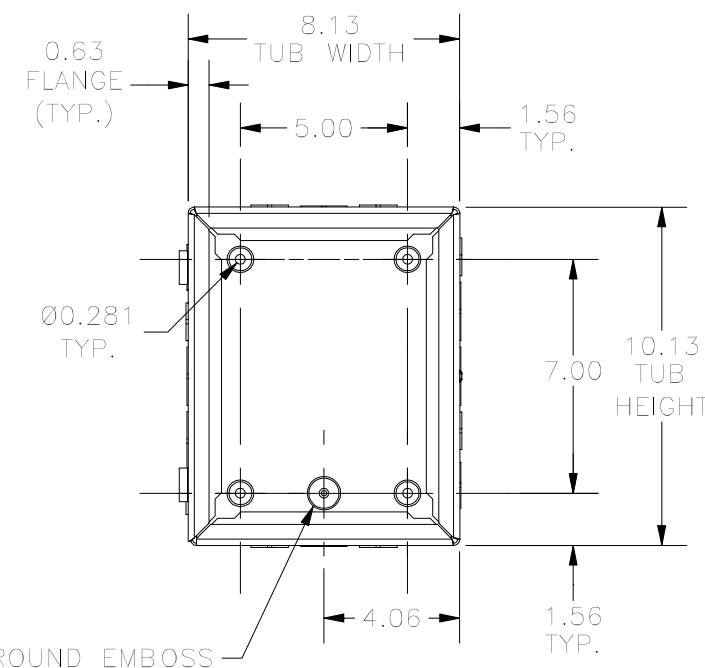
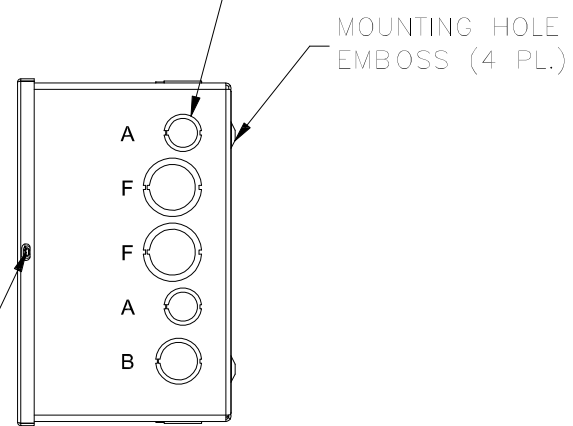

KNOCKOUT TABLE	
SIZE	DESCRIPTION
A	1/2" TO 3/4"
B	3/4 TO 1"
F	1" TO 1-1/4"

PART#: A081006

(DATA SUBJECT TO CHANGE WITHOUT NOTICE)

THIS DRAWING IS PROPERTY OF HUBBELL INC. WIEGMANN
ALL INFORMATION IS PROPRIETARY AND NOT TO BE DUPLICATED