

**TOP VIEW**

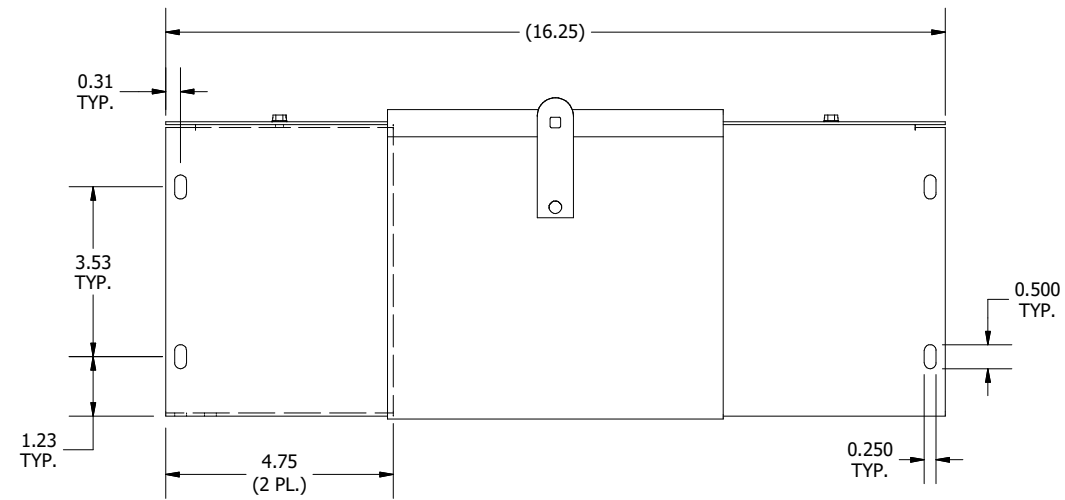

**FRONT VIEW, FULLY EXTENDED VIEW**

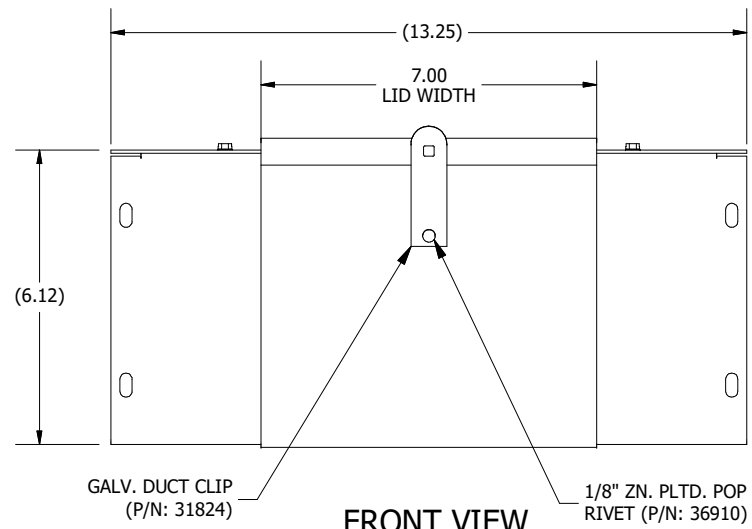

**FRONT VIEW**

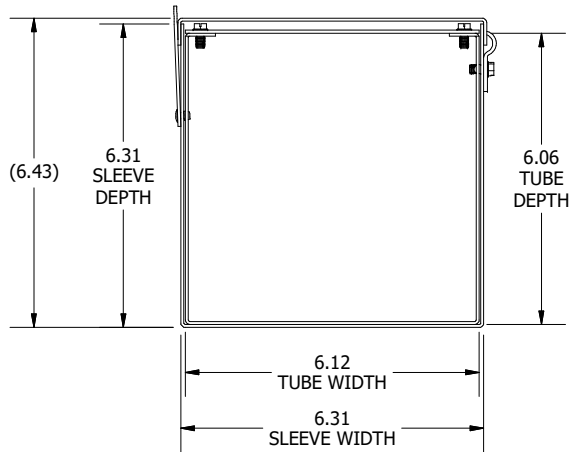

**SIDE VIEW**

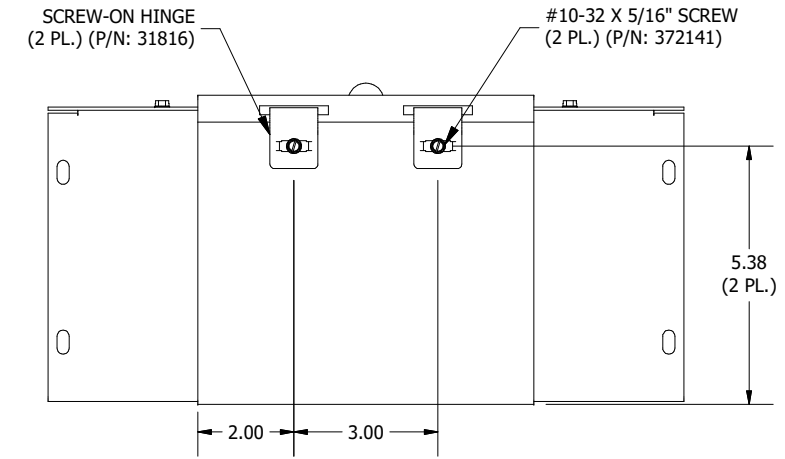

**REAR VIEW**

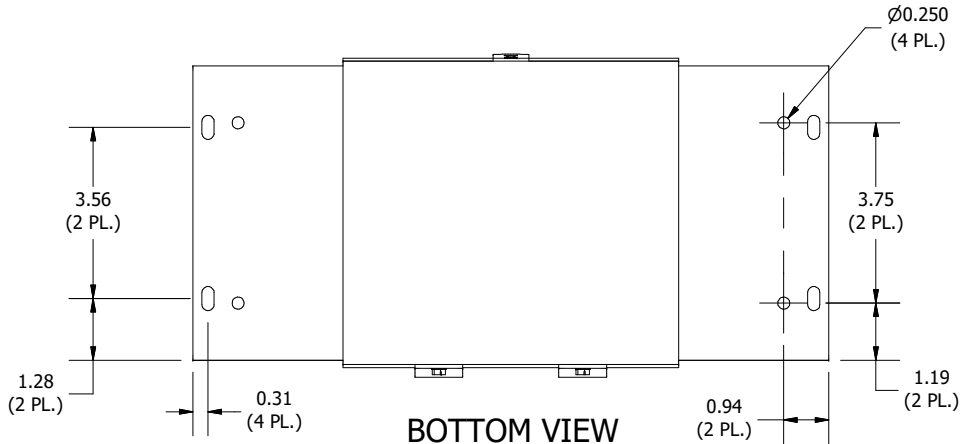

**BOTTOM VIEW**

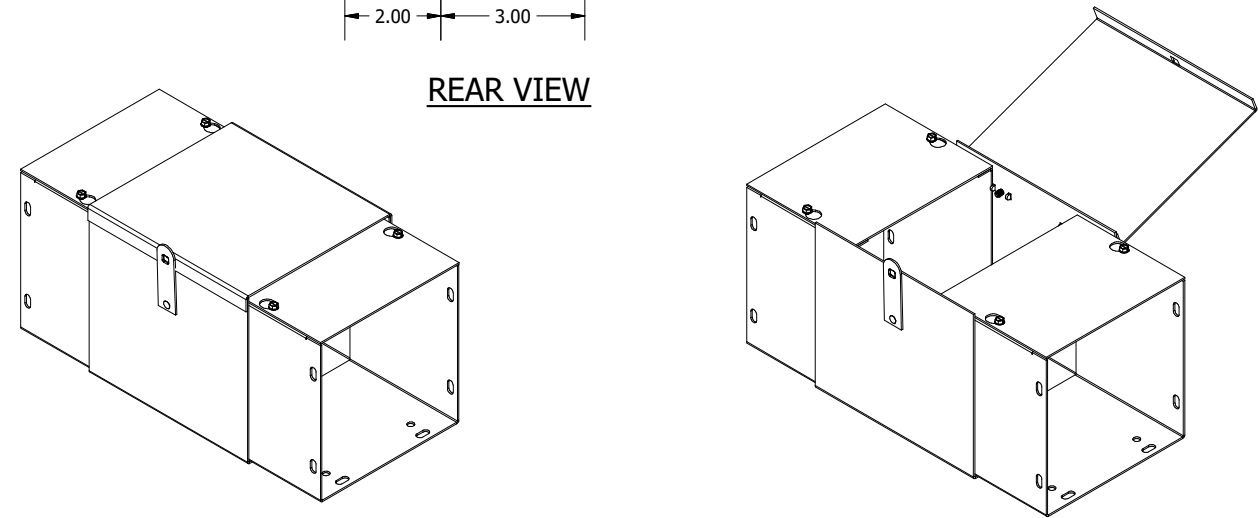

**PART#: AF0606G**  
**(DATA SUBJECT TO CHANGE WITHOUT NOTICE)**

THIS DRAWING IS PROPERTY OF HUBBELL INC. WIEGMANN  
 ALL INFORMATION IS PROPRIETARY AND NOT TO BE DUPLICATED