

LEFT SIDE

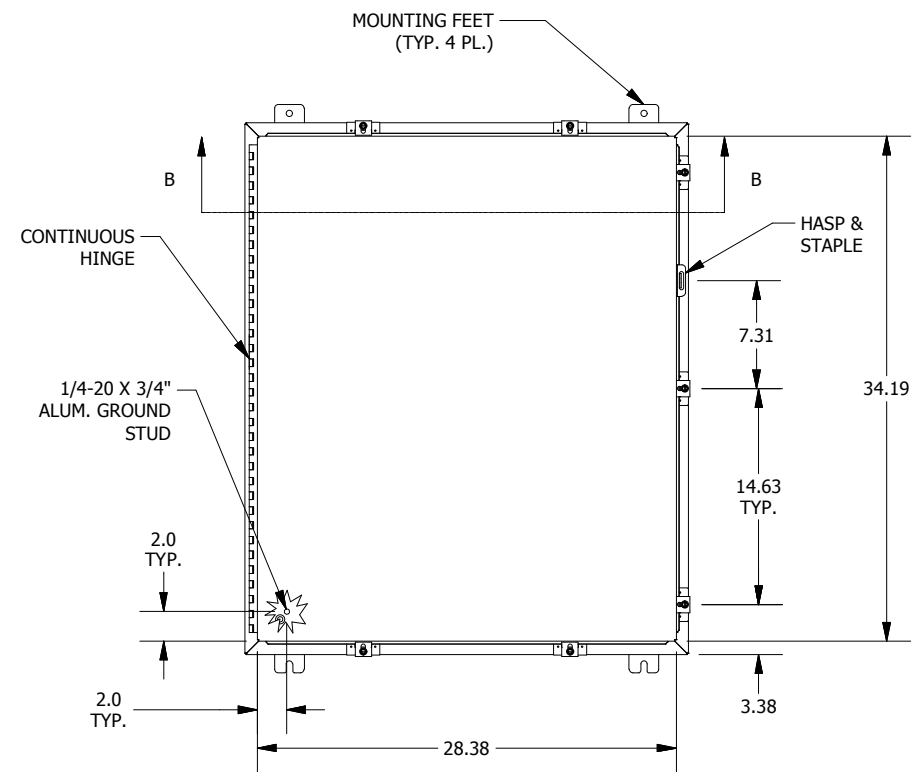

FRONT VIEW

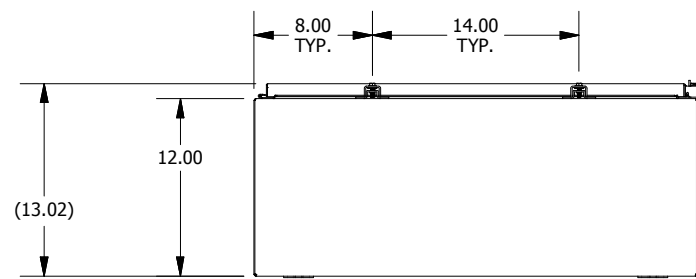

BOTTOM VIEW

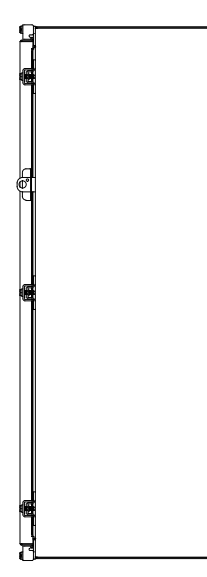

RIGHT VIEW

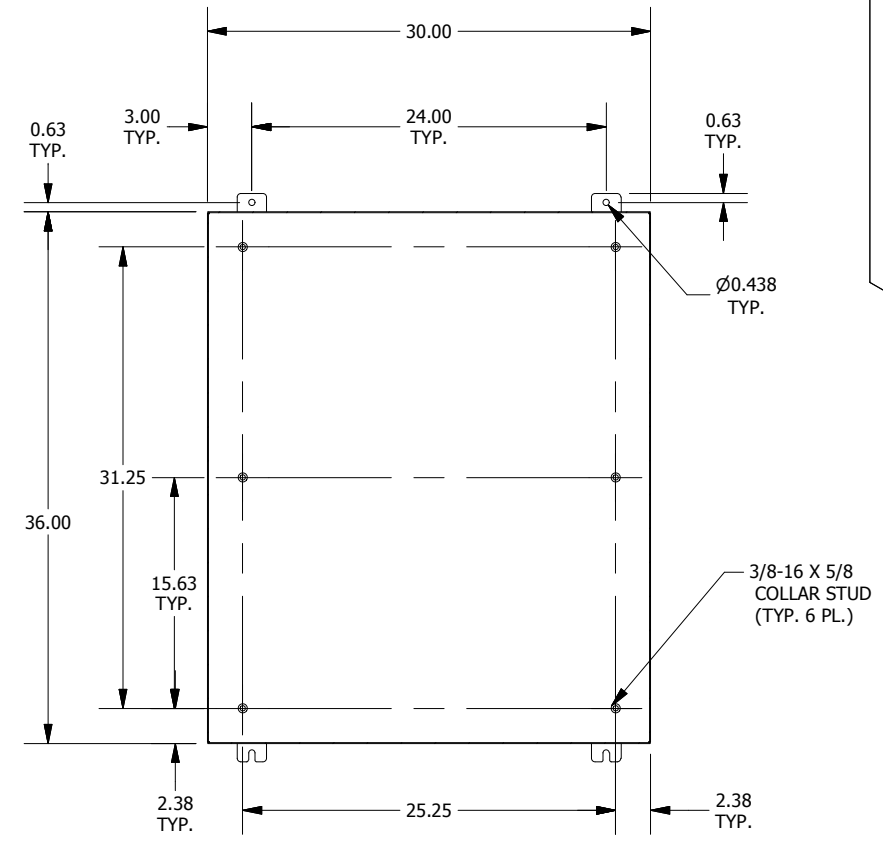

SECTION A-A

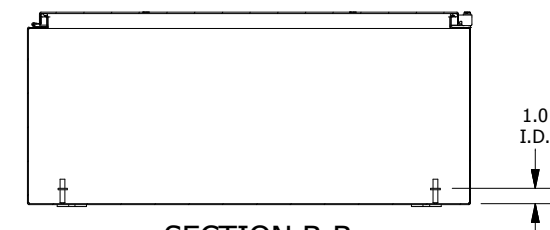

SECTION B-B

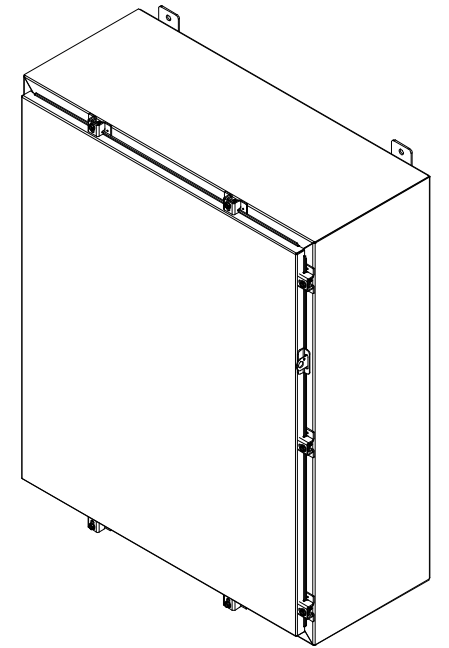

PART #:ALN4363012
 (DATA SUBJECT TO CHANGE WITHOUT NOTICE)
 THIS DRAWING IS THE PROPERTY OF HUBBELL INC. WIEGMANN
 ALL INFORMATION IS PROPRIETARY AND NOT TO BE DUPLICATED