

TOP VIEW

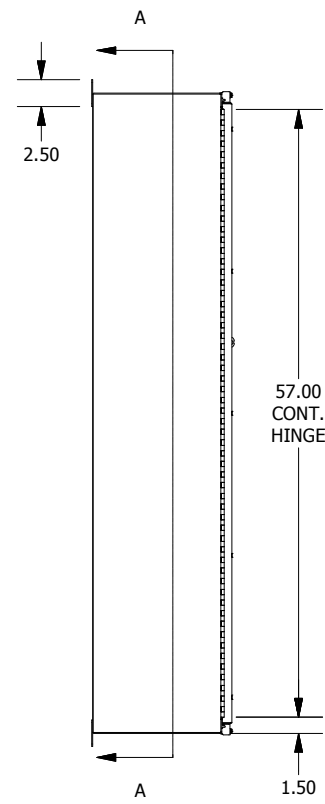

LEFT SIDE

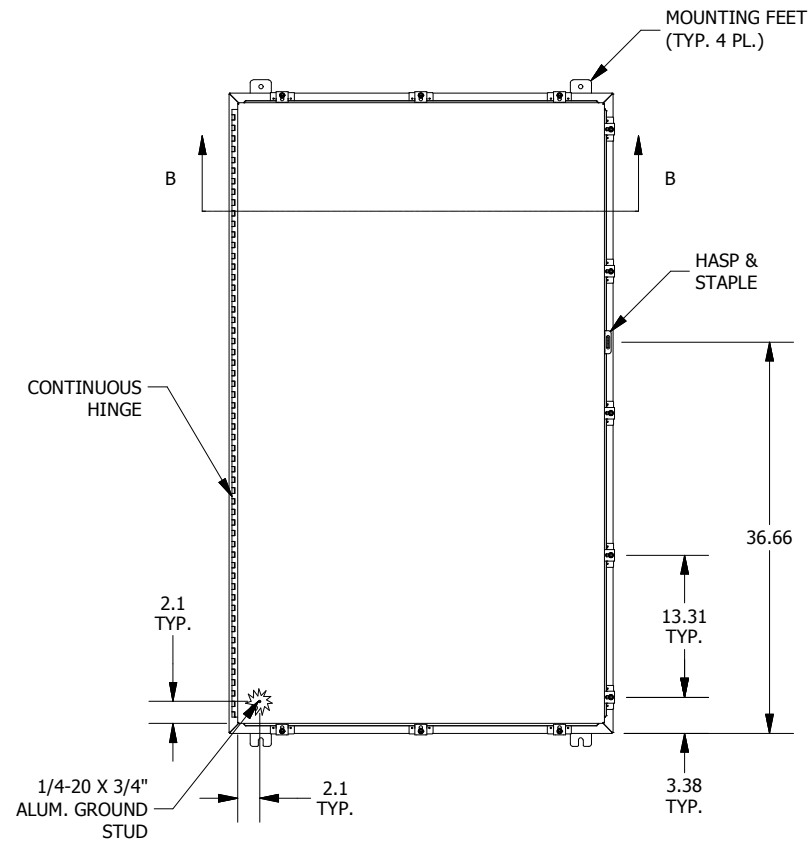

FRONT VIEW

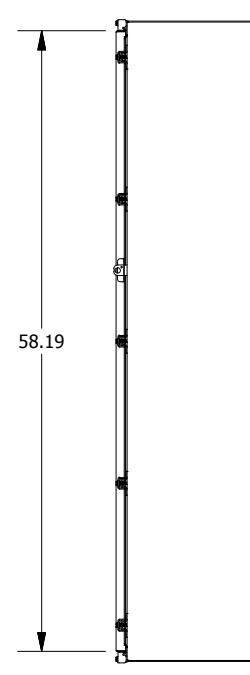

RIGHT SIDE

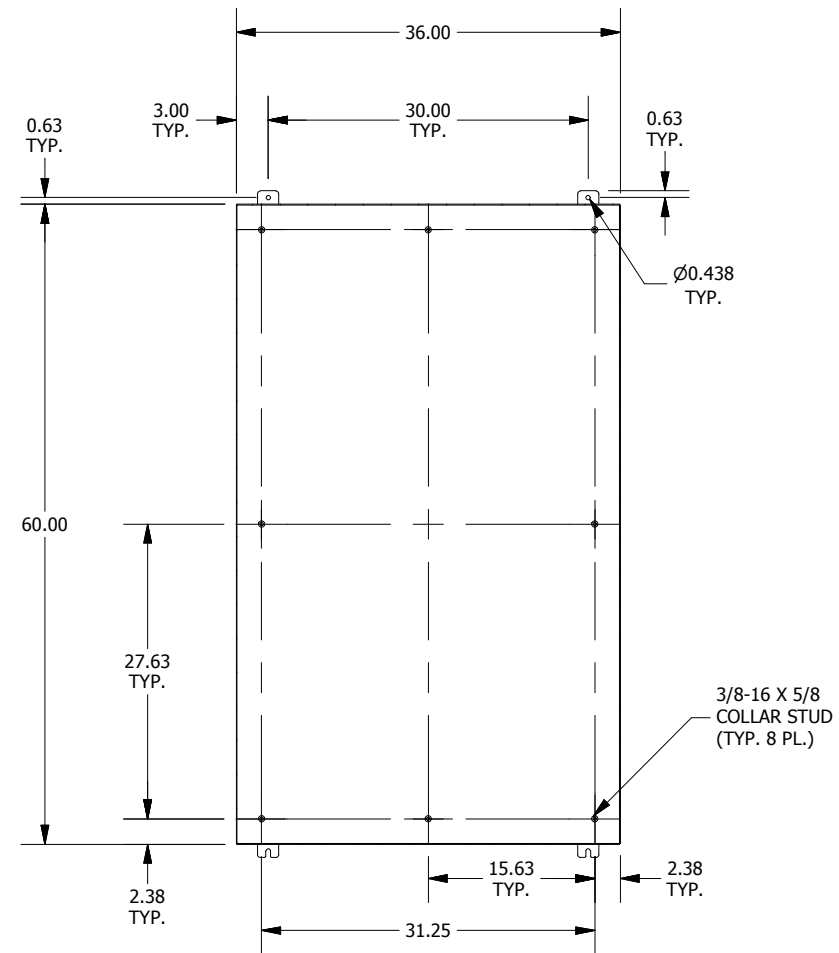

SECTION A-A
(INSIDE BACK OF TUB)

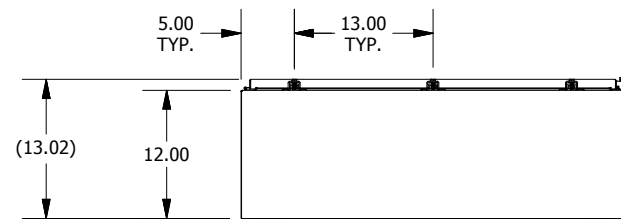

BOTTOM VIEW

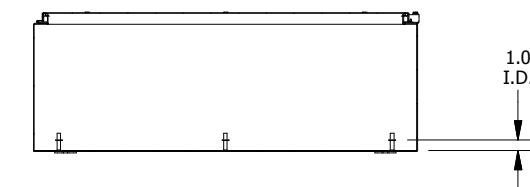

SECTION B-B
(INSIDE TOP OF ENCLOSURE)

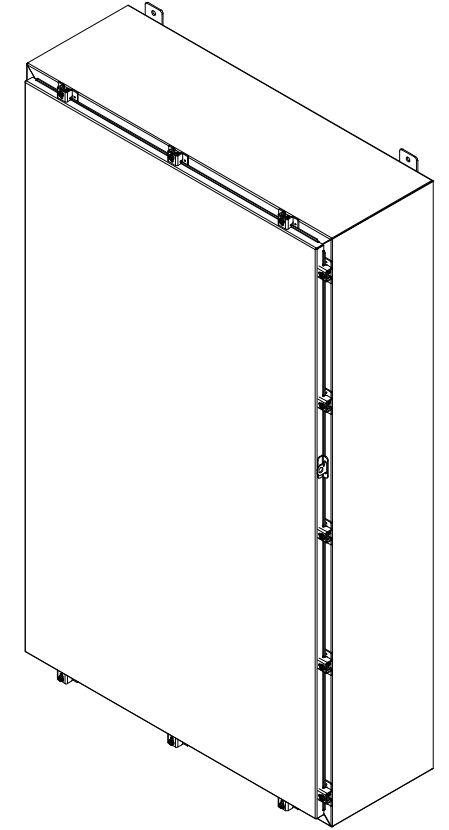

PART #:ALN4603612
 (DATA SUBJECT TO CHANGE WITHOUT NOTICE)
 THIS DRAWING IS THE PROPERTY OF HUBBELL INC. WIEGMANN
 ALL INFORMATION IS PROPRIETARY AND NOT TO BE DUPLICATED