

TOP VIEW

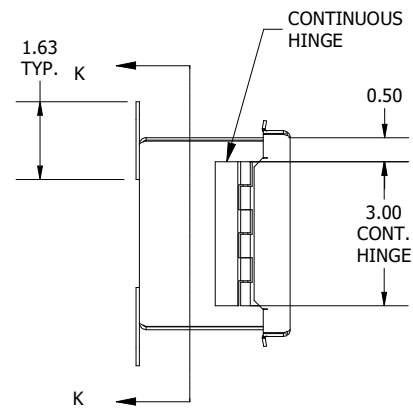

LEFT SIDE VIEW

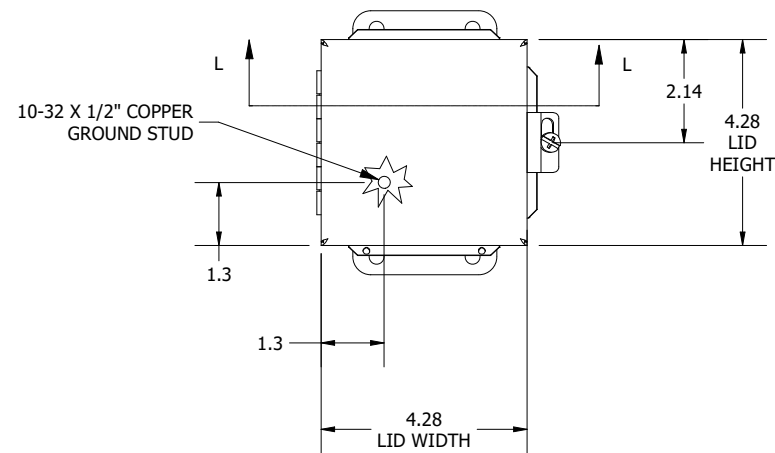

FRONT VIEW

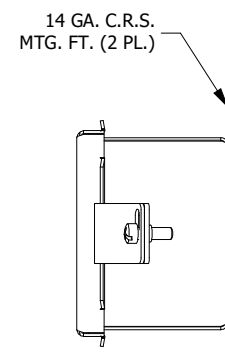

RIGHT SIDE VIEW

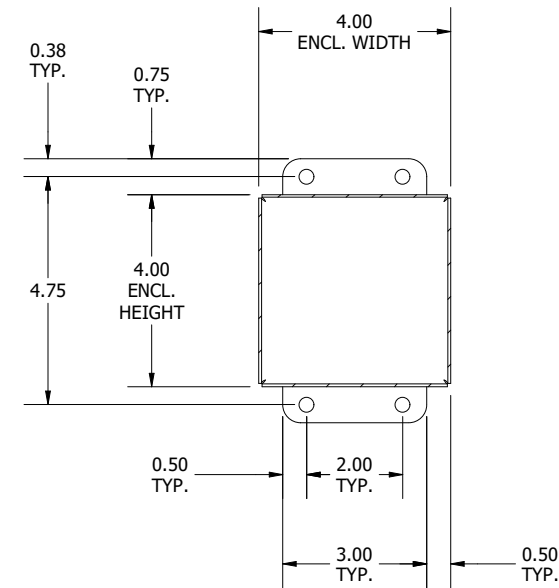

SECTION K-K  
(INSIDE BACK OF ENCLOSURE)

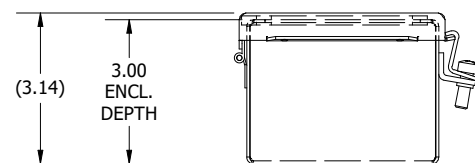
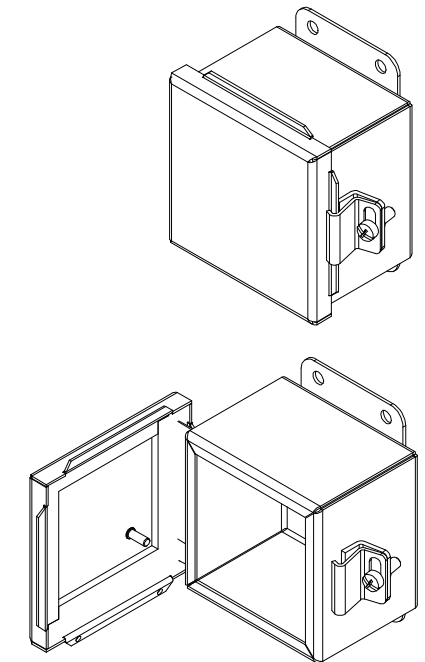

BOTTOM VIEW

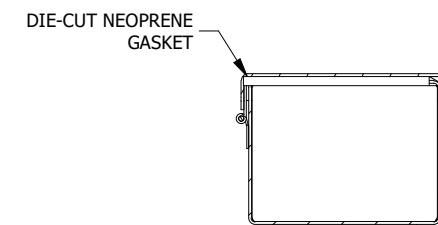

SECTION L-L VIEW  
(INSIDE TOP OF ENCL.)

PART #:B040403CH  
 (DATA SUBJECT TO CHANGE WITHOUT NOTICE)  
 THIS DRAWING IS THE PROPERTY OF HUBBELL INC. WIEGMANN  
 ALL INFORMATION IS PROPRIETARY AND NOT TO BE DUPLICATED