

**TOP VIEW**

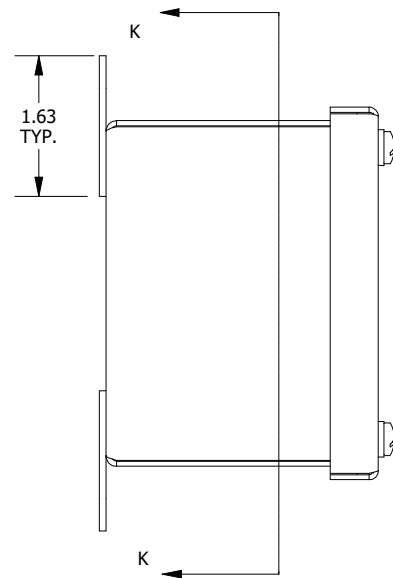

**LEFT SIDE VIEW**

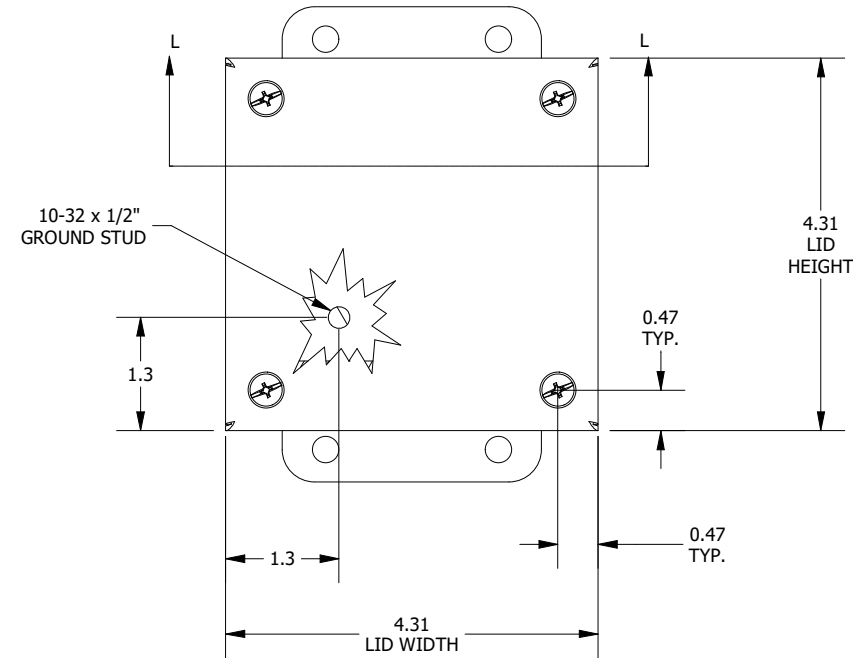

**FRONT VIEW**

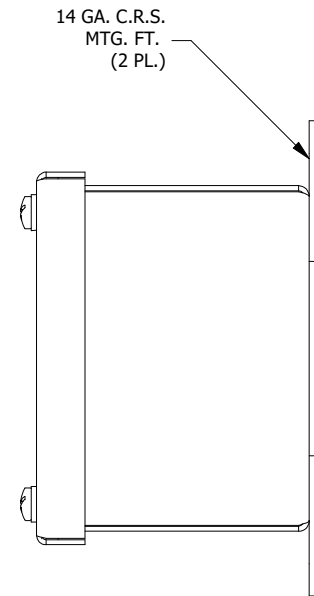

**RIGHT SIDE VIEW**

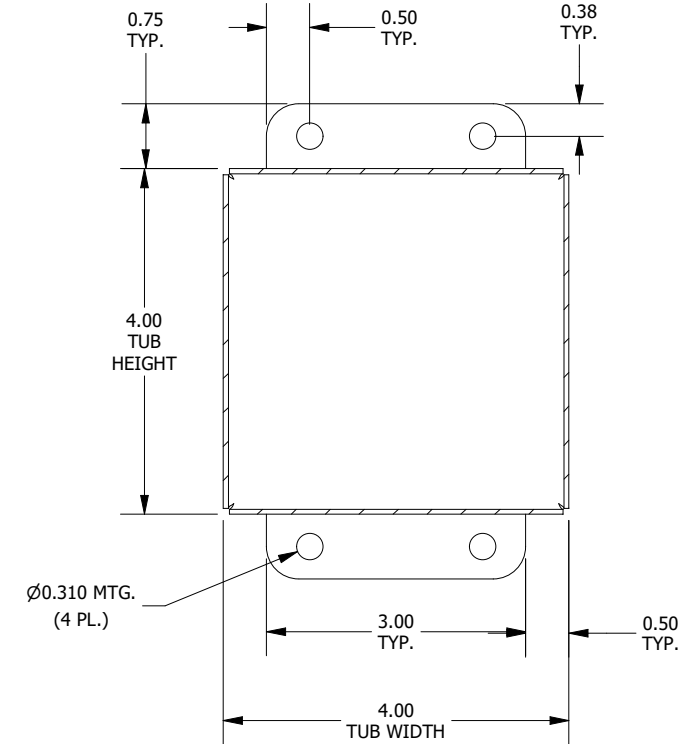

**SECTION K-K  
(INSIDE BACK OF ENCLOSURE)**

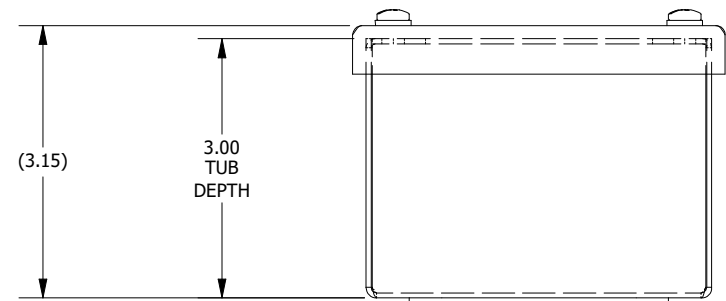

**BOTTOM VIEW**

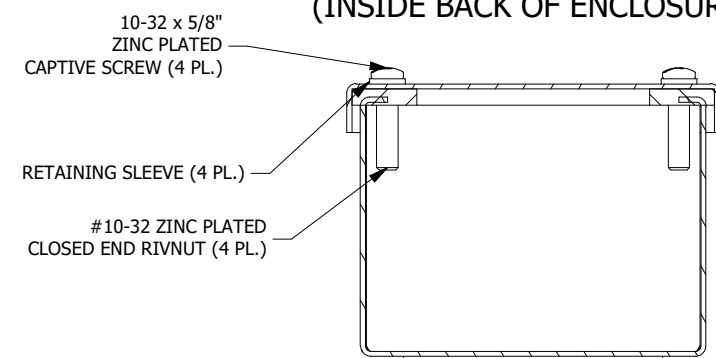

**SECTION L-L VIEW  
(INSIDE TOP OF ENCL.)**

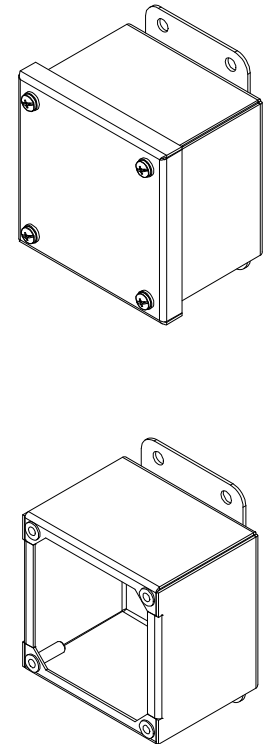

**PART #:B040403SC**  
 (DATA SUBJECT TO CHANGE WITHOUT NOTICE)  
 THIS DRAWING IS THE PROPERTY OF HUBBELL INC. WIEGMANN  
 ALL INFORMATION IS PROPRIETARY AND NOT TO BE DUPLICATED