

TOP VIEW

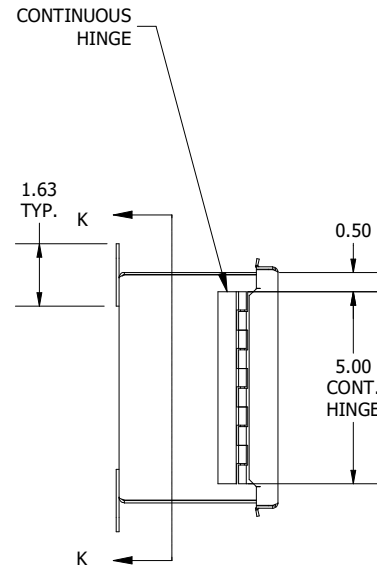

LEFT SIDE VIEW

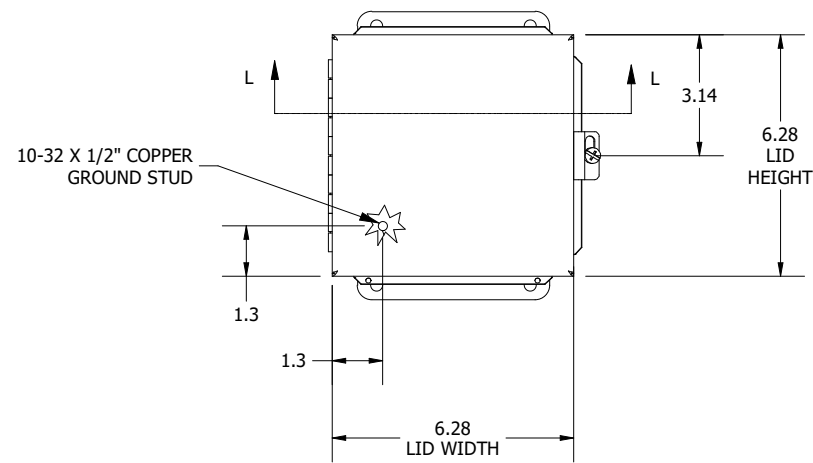

FRONT VIEW

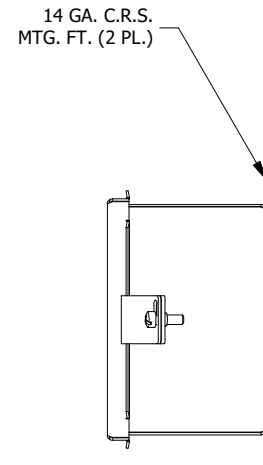

RIGHT SIDE VIEW

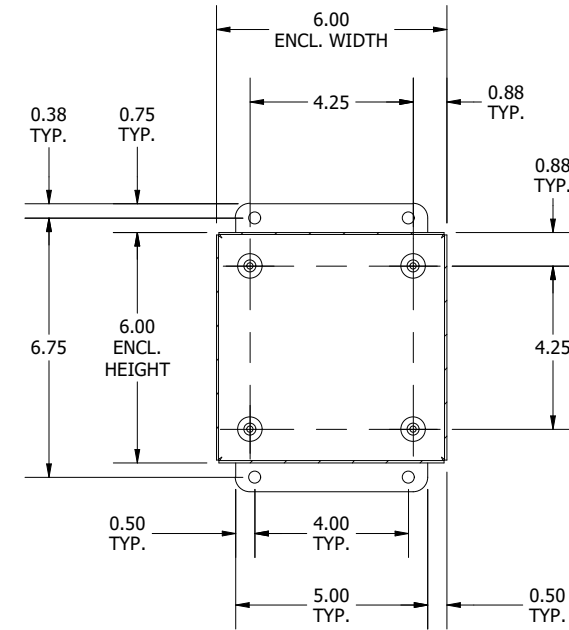

**SECTION K-K
(INSIDE BACK OF ENCLOSURE)**

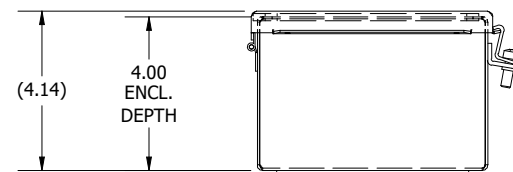
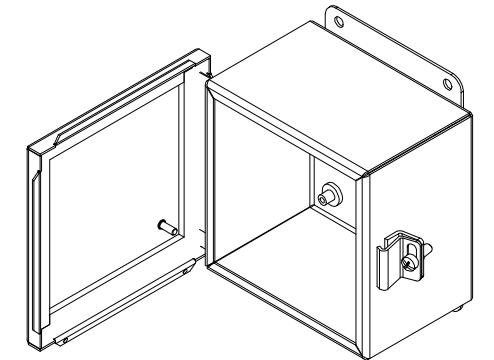
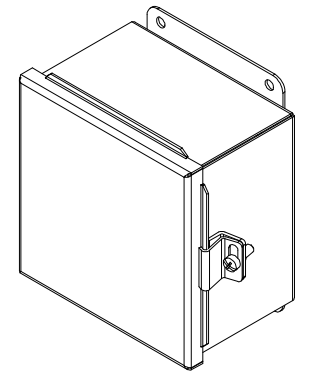

BOTTOM VIEW

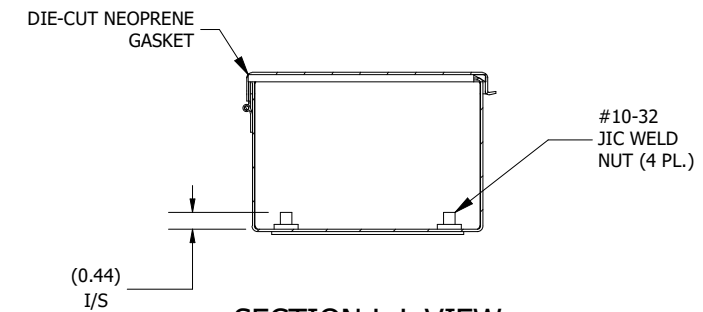

**SECTION L-L VIEW
(INSIDE TOP OF ENCL.)**

PART #:B060604CH
 (DATA SUBJECT TO CHANGE WITHOUT NOTICE)
 THIS DRAWING IS THE PROPERTY OF HUBBELL INC. WIEGMANN
 ALL INFORMATION IS PROPRIETARY AND NOT TO BE DUPLICATED