

**LEFT SIDE VIEW**

**FRONT VIEW**

**RIGHT SIDE VIEW**

**SECTION K-K (INSIDE BACK OF ENCLOSURE)**

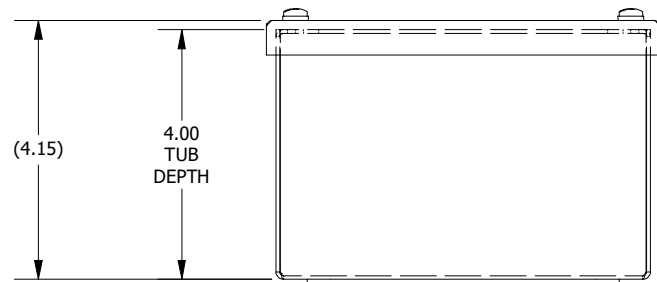

**BOTTOM VIEW**

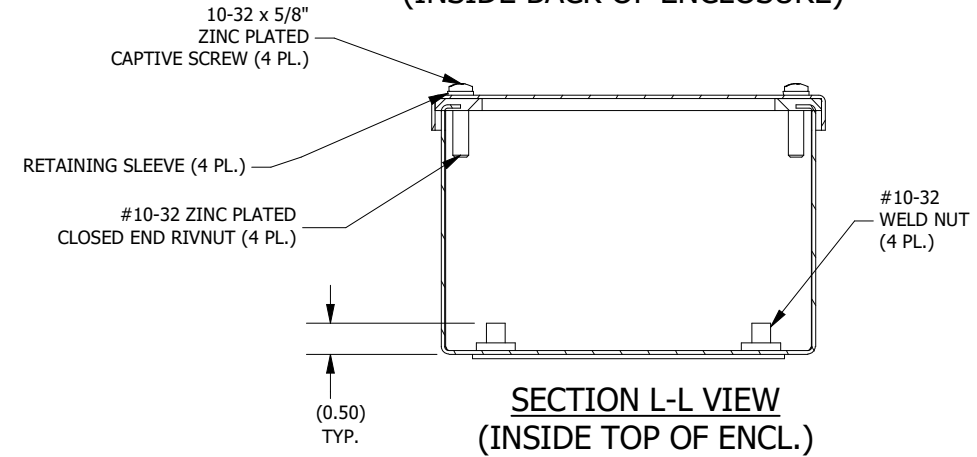

**SECTION L-L VIEW (INSIDE TOP OF ENCL.)**

**PART #:B060604SC**  
 (DATA SUBJECT TO CHANGE WITHOUT NOTICE)  
 THIS DRAWING IS THE PROPERTY OF HUBBELL INC. WIEGMANN  
 ALL INFORMATION IS PROPRIETARY AND NOT TO BE DUPLICATED