

LEFT SIDE VIEW

TOP VIEW

FRONT VIEW

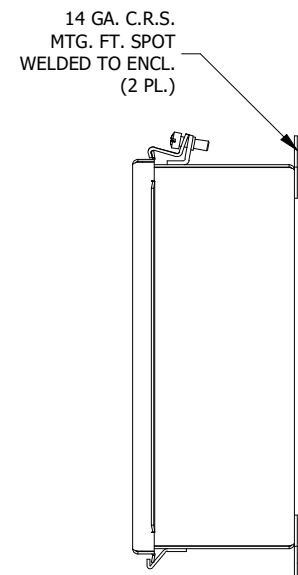

RIGHT SIDE VIEW

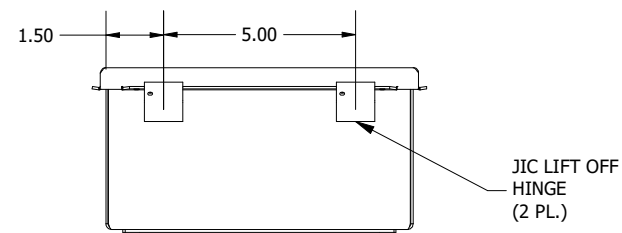

BOTTOM VIEW

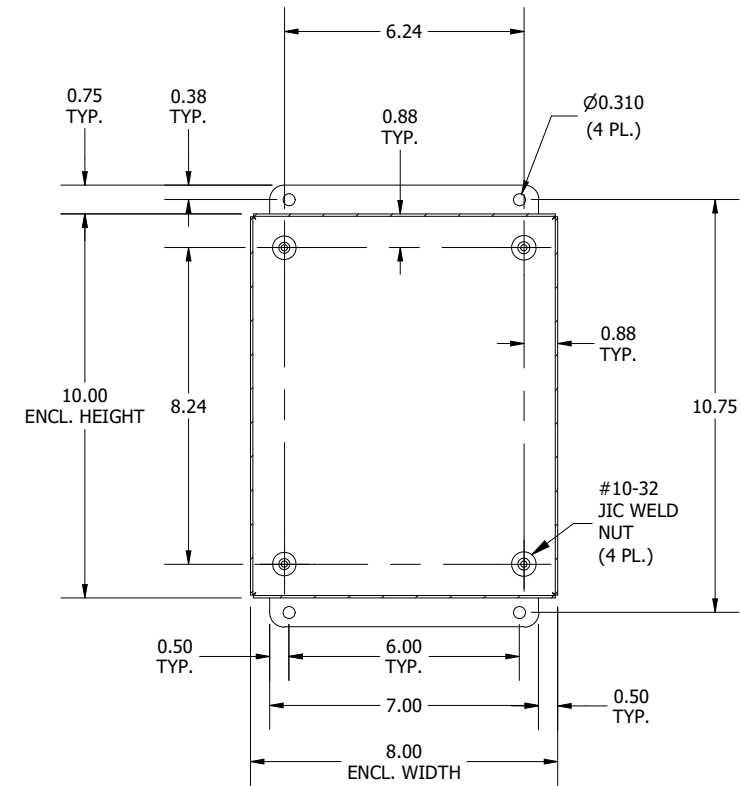

SECTION M-M
(INSIDE BACK OF ENCLOSURE)

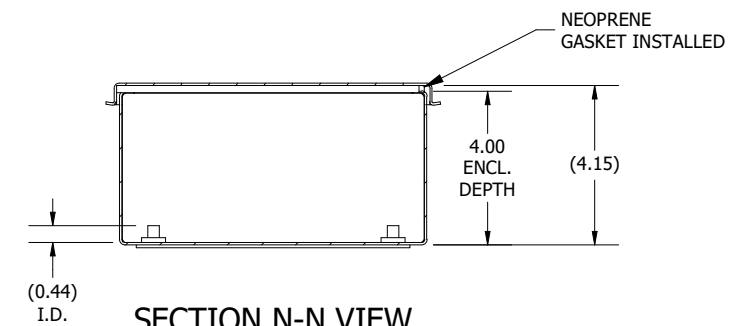

SECTION N-N VIEW
(INSIDE TOP OF ENCL.)

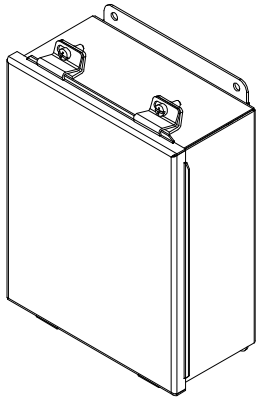

PART #:B100804

(DATA SUBJECT TO CHANGE WITHOUT NOTICE)

THIS DRAWING IS THE PROPERTY OF HUBBELL INC. WIEGMANN

ALL INFORMATION IS PROPRIETARY AND NOT TO BE DUPLICATED