

LEFT SIDE VIEW

FRONT VIEW

RIGHT SIDE VIEW

SECTION C-C  
 (INSIDE BACK OF ENCLOSURE)



BOTTOM VIEW

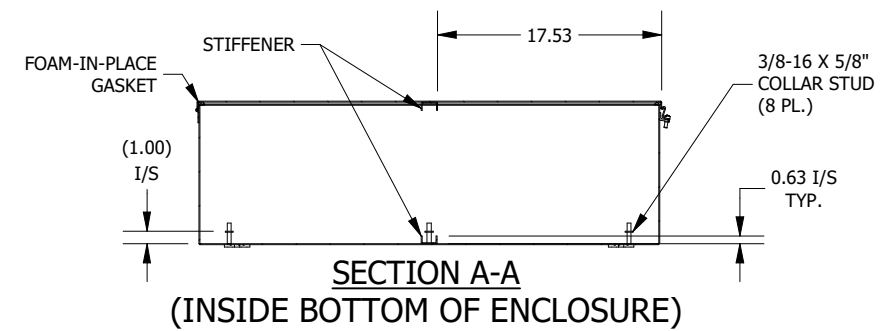

SECTION A-A  
 (INSIDE BOTTOM OF ENCLOSURE)

PART #:B483611CH  
 (DATA SUBJECT TO CHANGE WITHOUT NOTICE)  
 THIS DRAWING IS THE PROPERTY OF HUBBELL INC. WIEGMANN  
 ALL INFORMATION IS PROPRIETARY AND NOT TO BE DUPLICATED