

TOP VIEW

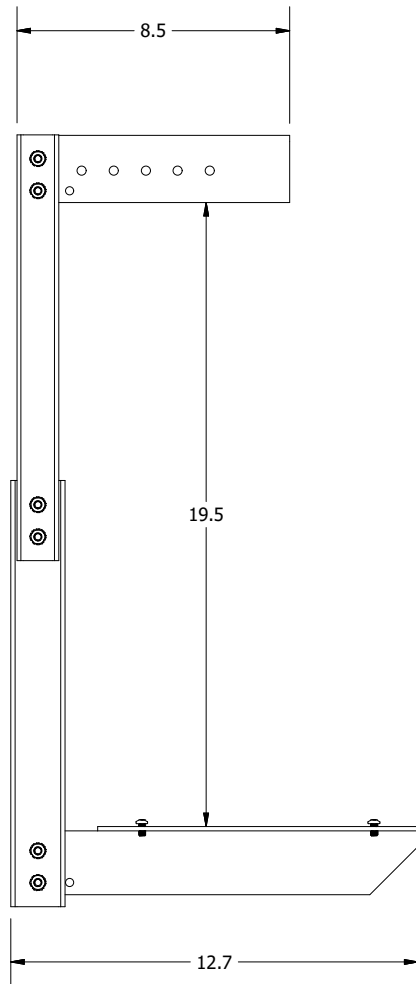

LEFT SIDE VIEW

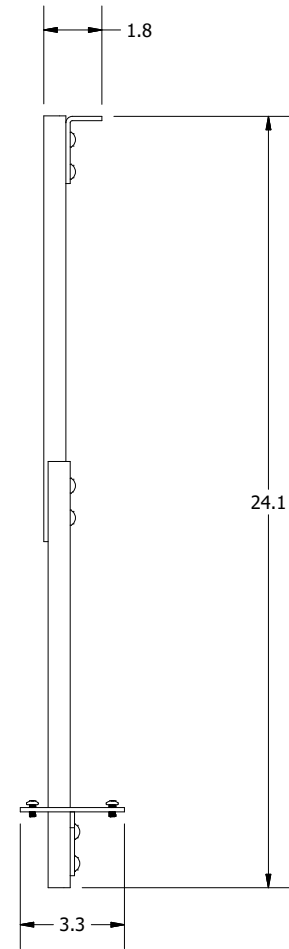

ASSM. FRONT VIEW

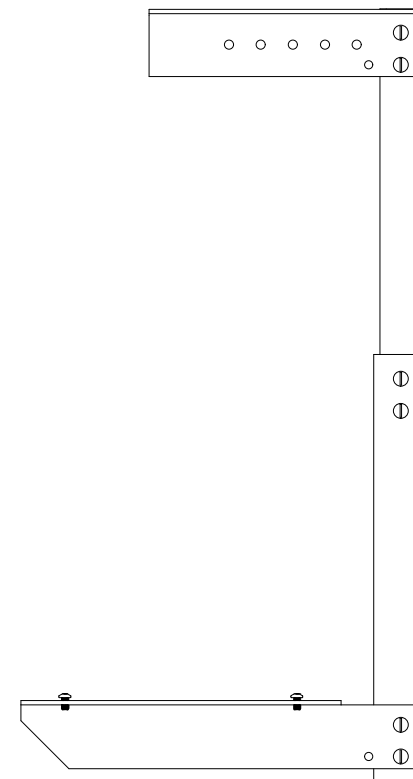

RIGHT SIDE VIEW

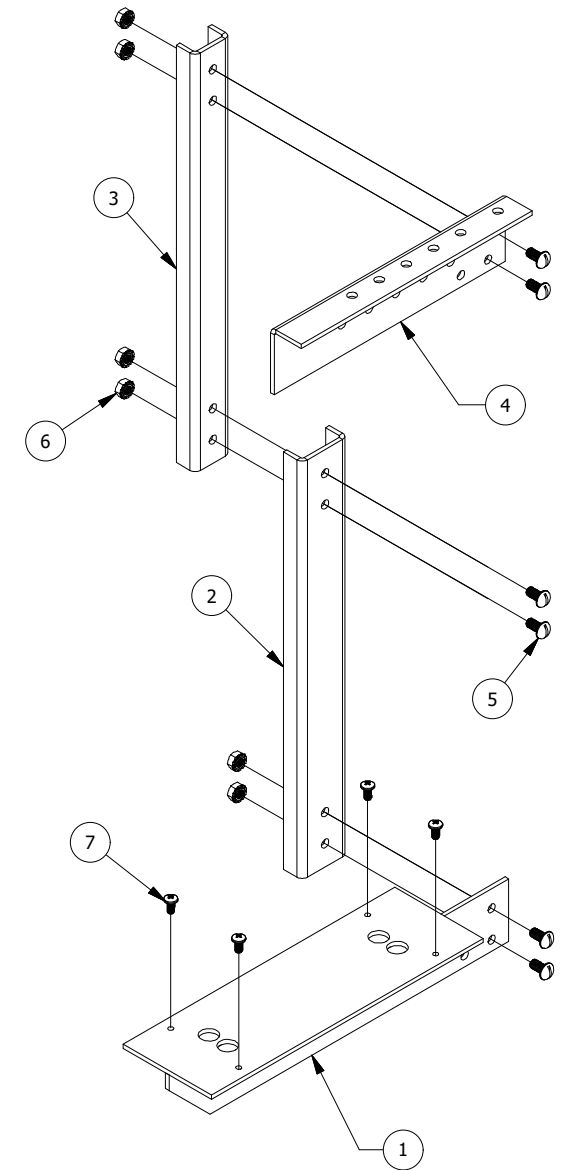

PARTS LIST			
ITEM	PART NUMBER	DESCRIPTION	QTY
1	BH1010BTM	BOTTOM MOUNTING PLATE WELDMENT	1
2	BH1010BS	BOTTOM STRAP	1
3	BH1010TS	TOP STRAP	1
4	BH1010TOP	TOP PLATE	1
5	37242	1/4-28 X 1/2" ZN PLTD RHD HD, SLTD MS	6
6	34937	1/4-28 ZN PLTD KEP NUT	6
7	372110	#10-32 X 3/8" ZN PLTD PAN HD, PHIL MS	4

PART #:BH1010

(DATA SUBJECT TO CHANGE WITHOUT NOTICE)

THIS DRAWING IS THE PROPERTY OF HUBBELL INC. WIEGMANN
ALL INFORMATION IS PROPRIETARY AND NOT TO BE DUPLICATED