

**TOP VIEW**

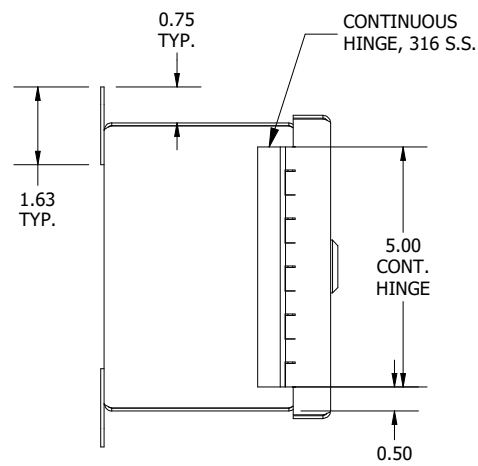

**LEFT SIDE VIEW**

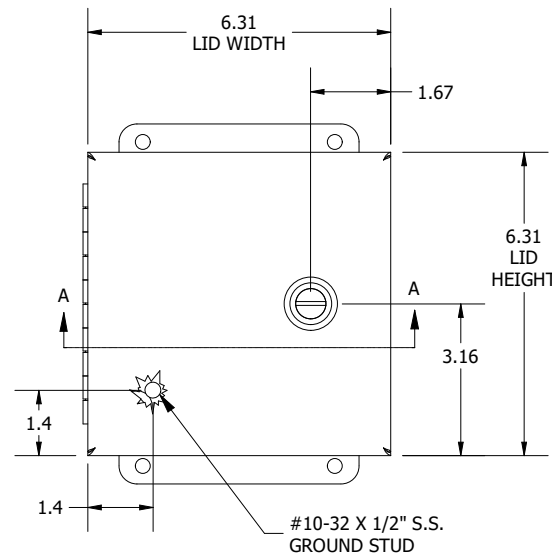

**FRONT VIEW**

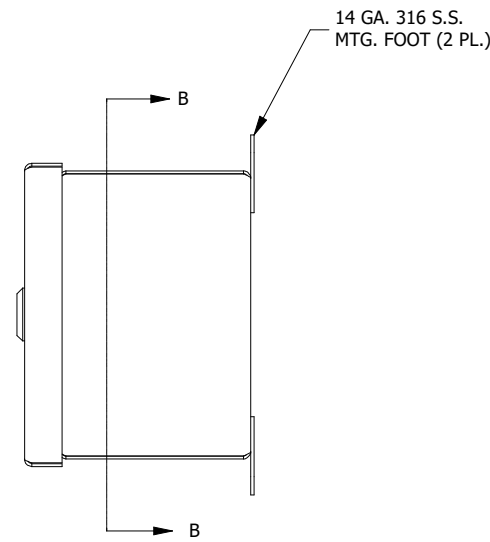

**RIGHT SIDE VIEW**

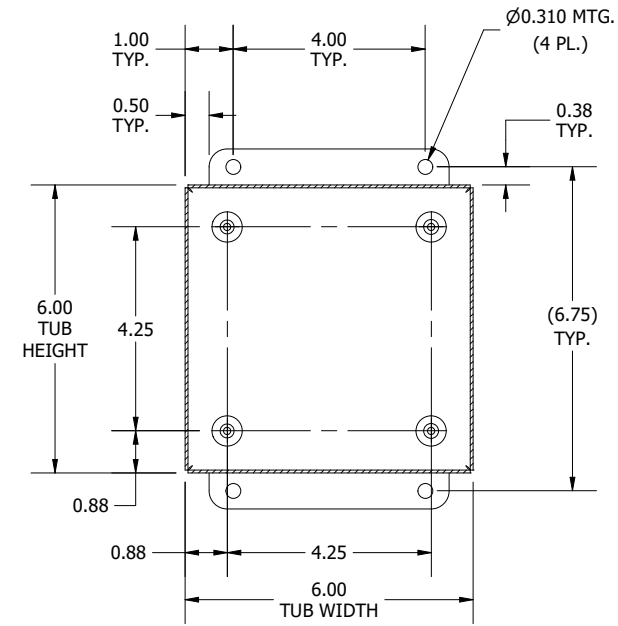

**SECTION B-B  
(INSIDE BACK OF ENCL.)**

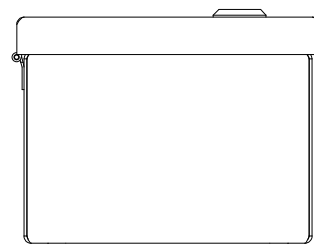
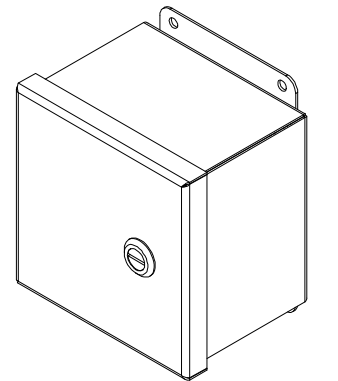
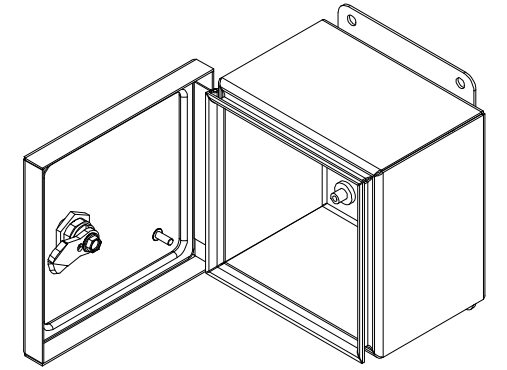

**BOTTOM VIEW**

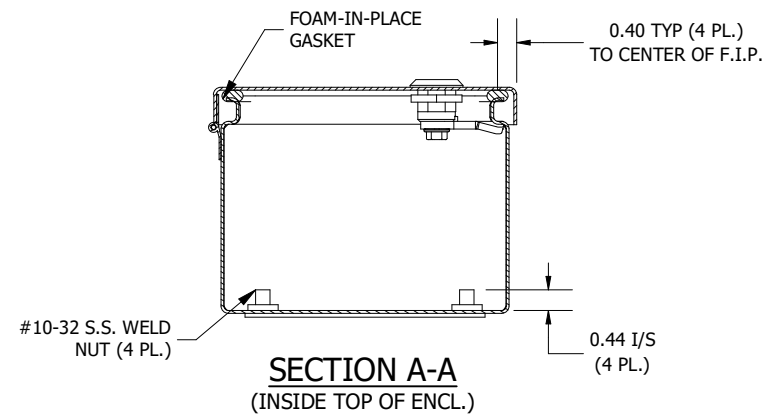

**SECTION A-A  
(INSIDE TOP OF ENCL.)**

**PART #:BN4060604CHQTSSA**  
 (DATA SUBJECT TO CHANGE WITHOUT NOTICE)  
 THIS DRAWING IS THE PROPERTY OF HUBBELL INC. WIEGMANN  
 ALL INFORMATION IS PROPRIETARY AND NOT TO BE DUPLICATED