

TOP VIEW

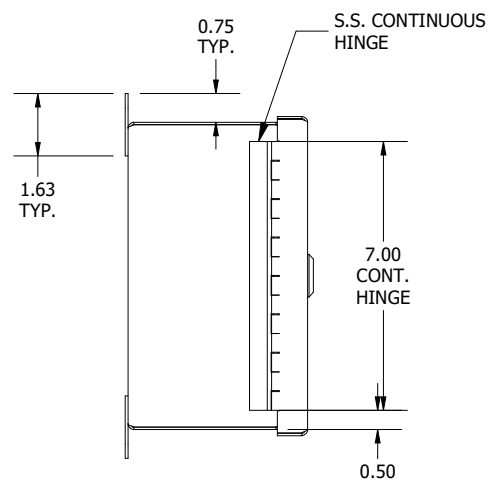

LEFT SIDE VIEW

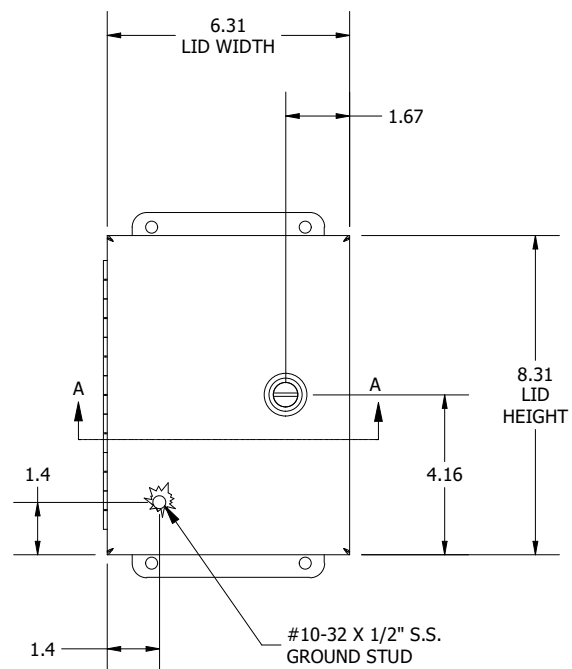

FRONT VIEW

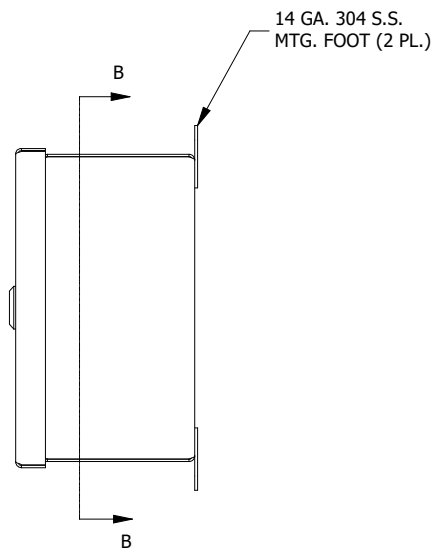

RIGHT SIDE VIEW

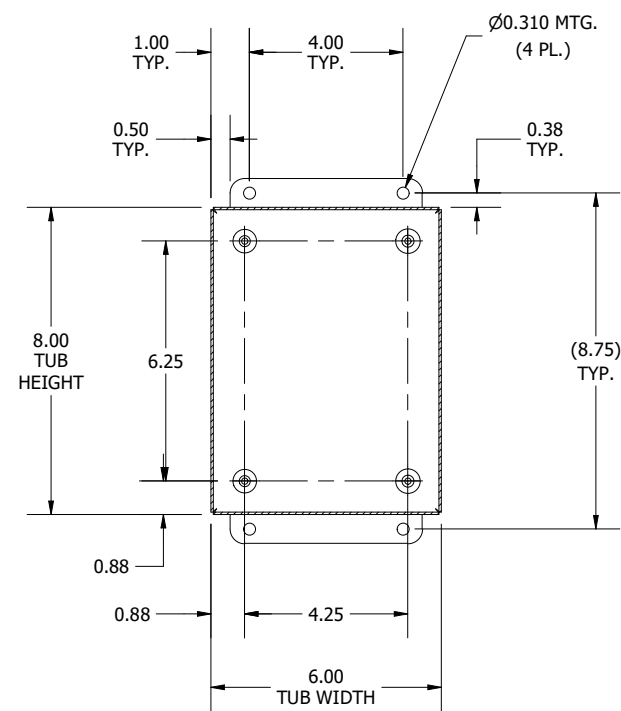

**SECTION B-B
(INSIDE BACK OF ENCL.)**

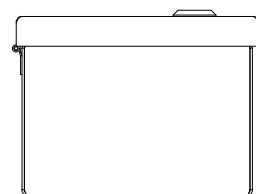
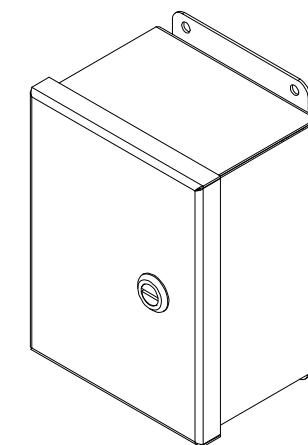
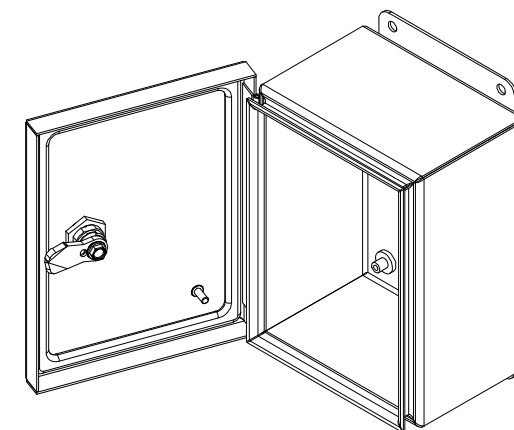

BOTTOM VIEW

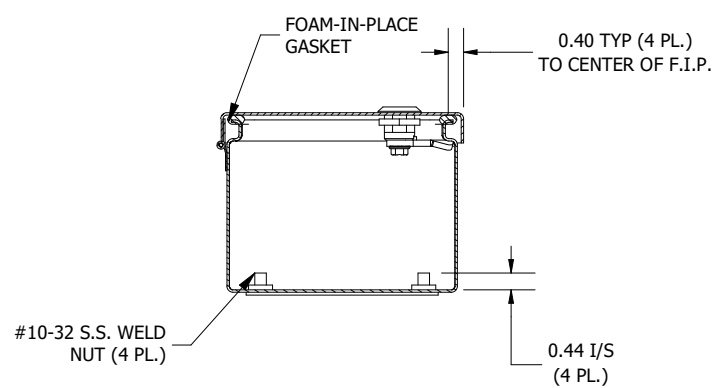

**SECTION A-A
(INSIDE TOP OF ENCL.)**

PART #:BN4080604CHQTSS
 (DATA SUBJECT TO CHANGE WITHOUT NOTICE)
 THIS DRAWING IS THE PROPERTY OF HUBBELL INC. WIEGMANN
 ALL INFORMATION IS PROPRIETARY AND NOT TO BE DUPLICATED