

TOP VIEW

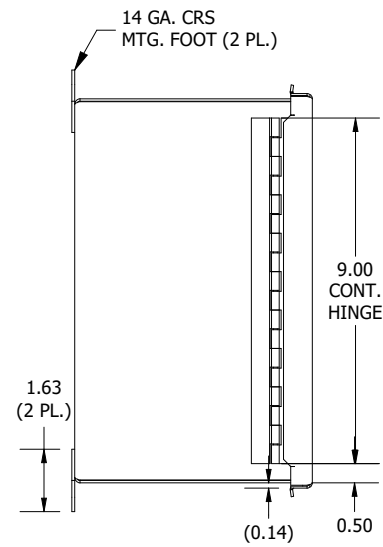

LEFT SIDE VIEW

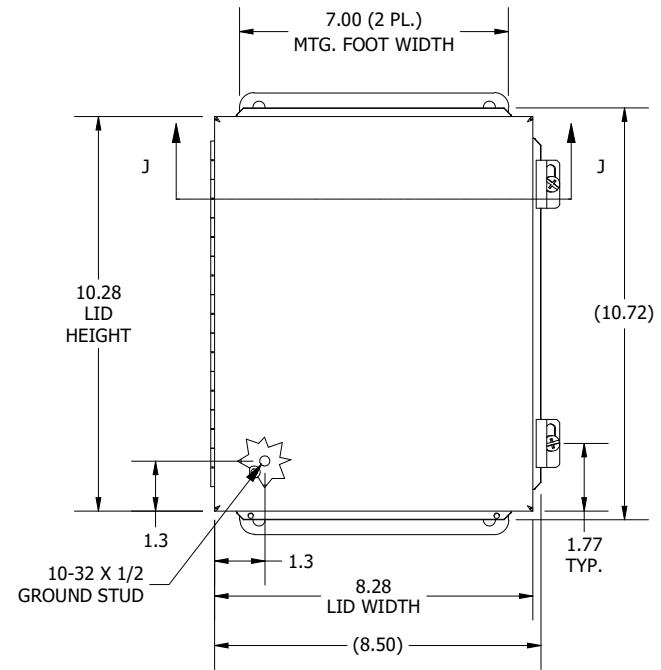

FRONT VIEW

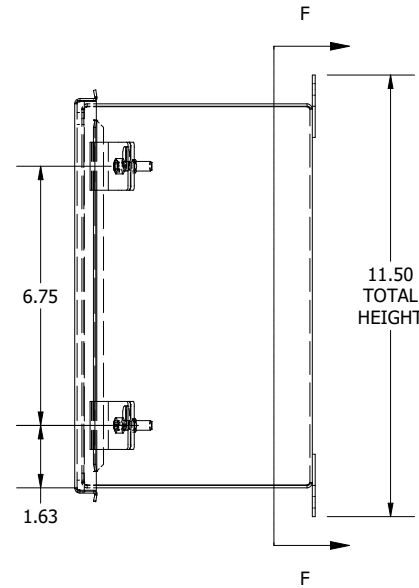

RIGHT SIDE VIEW

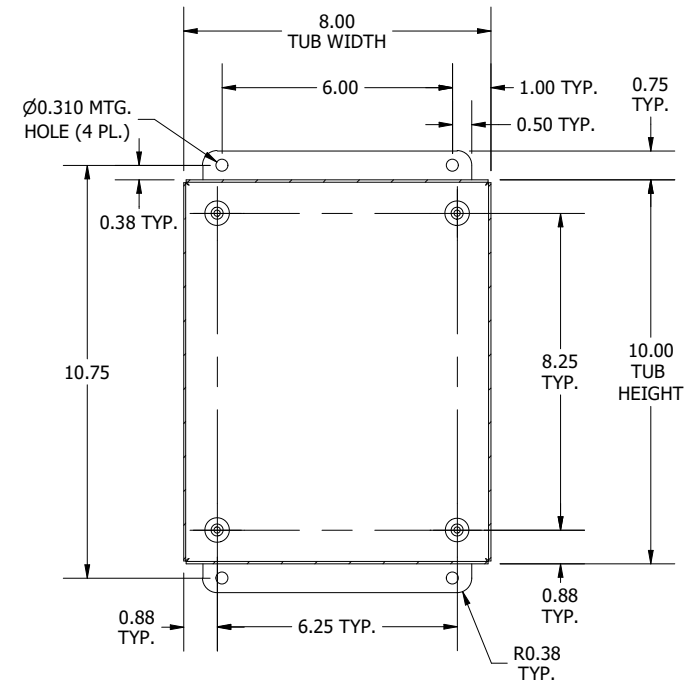

**SECTION F-F
(INSIDE BACK OF ENCL.)**

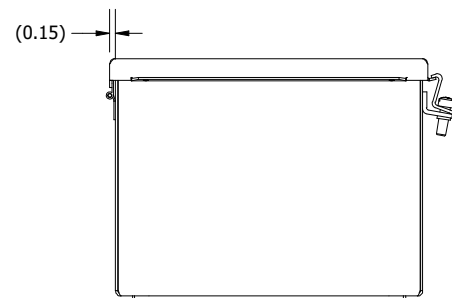

BOTTOM VIEW

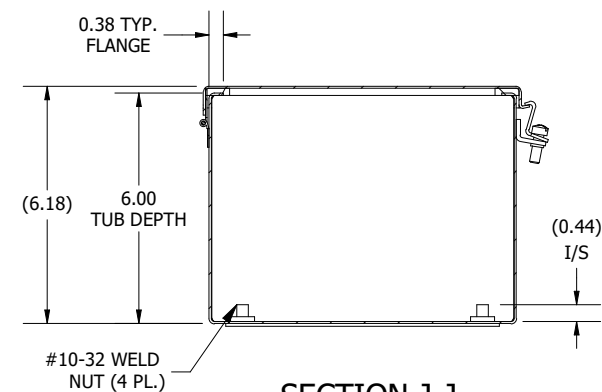

**SECTION J-J
(INSIDE TOP OF ENCL.)**

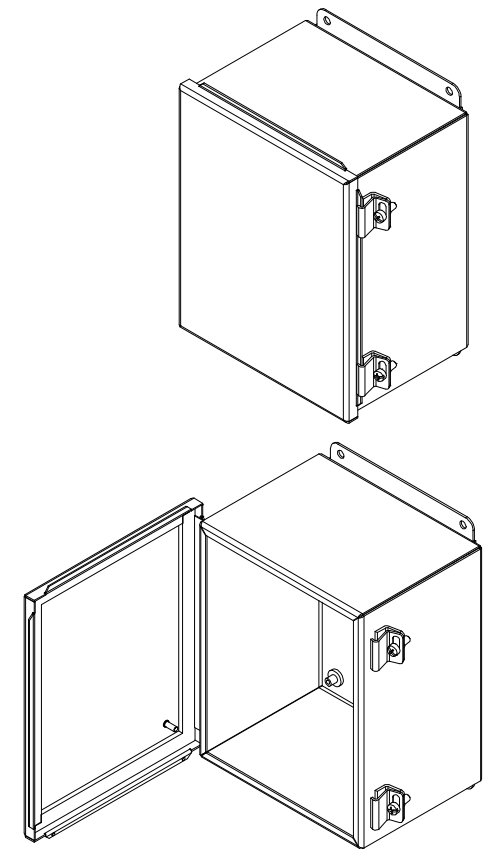

PART #:BN4100806CH
 (DATA SUBJECT TO CHANGE WITHOUT NOTICE)
 THIS DRAWING IS THE PROPERTY OF HUBBELL INC. WIEGMANN
 ALL INFORMATION IS PROPRIETARY AND NOT TO BE DUPLICATED