

**TOP VIEW**

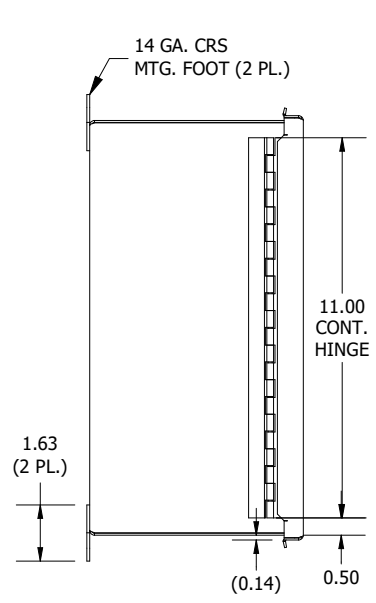

**LEFT SIDE VIEW**

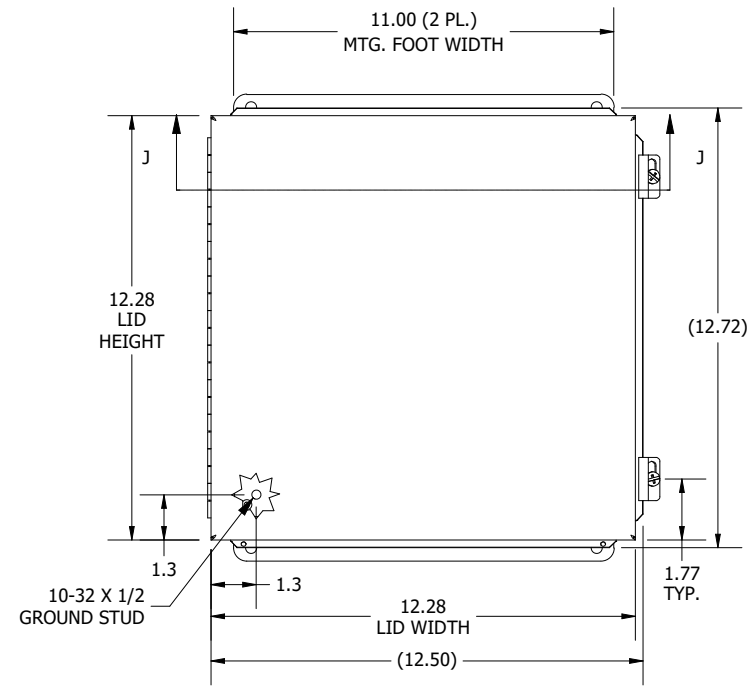

**FRONT VIEW**

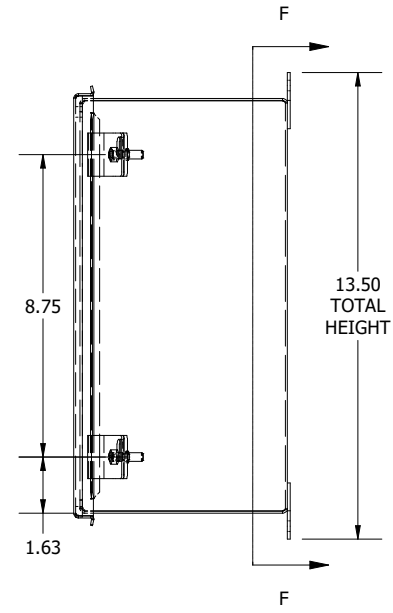

**RIGHT SIDE VIEW**

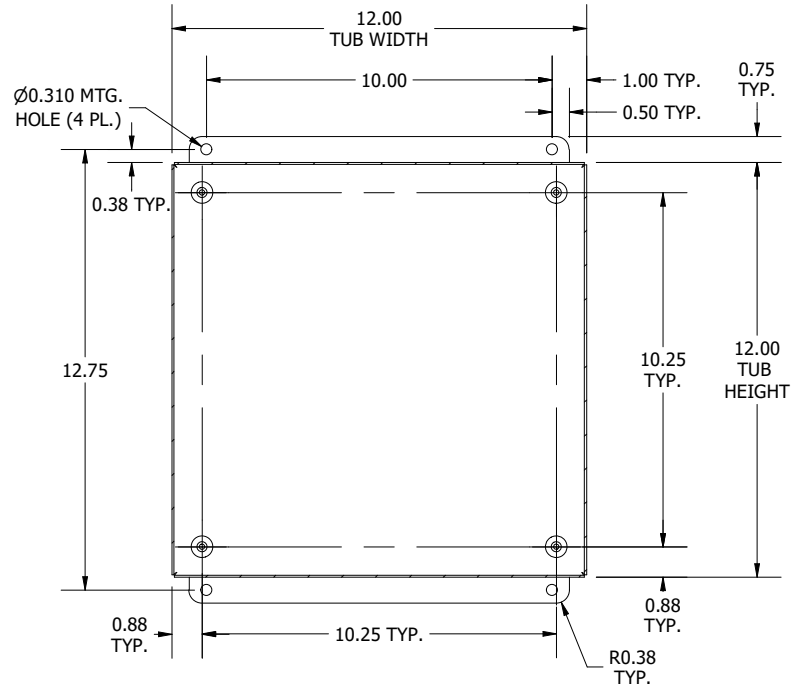

**SECTION F-F (INSIDE BACK OF ENCL.)**

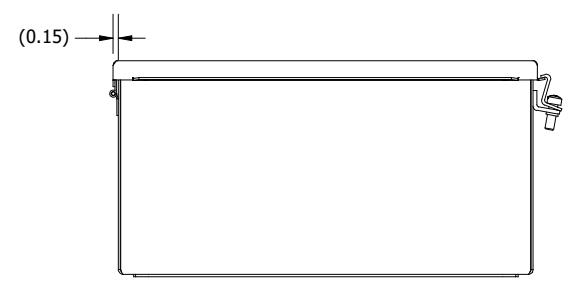

**BOTTOM VIEW**

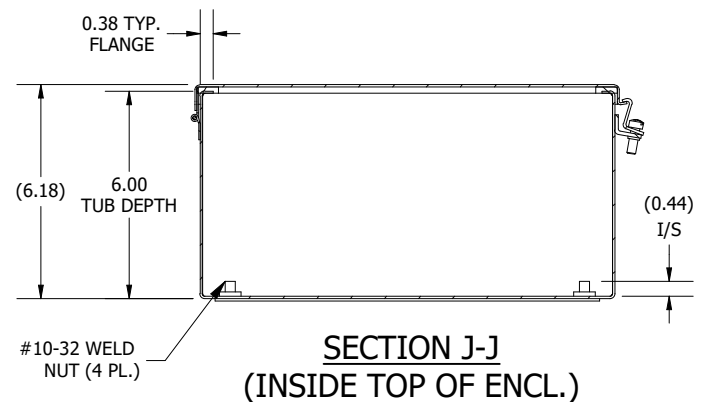

**SECTION J-J (INSIDE TOP OF ENCL.)**

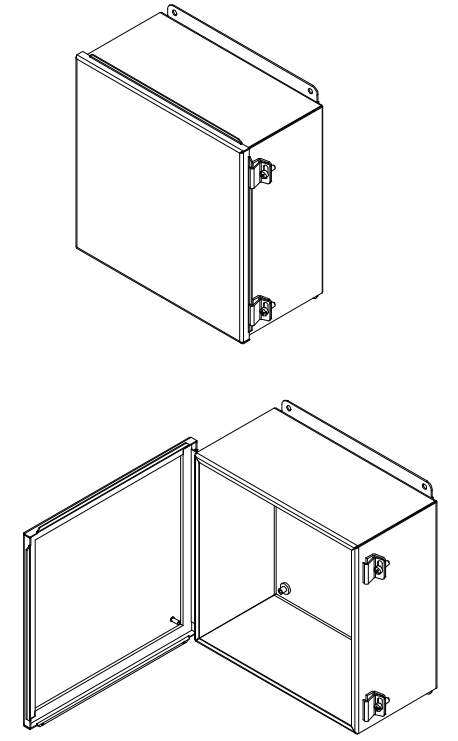

PART #:BN4121206CH  
 (DATA SUBJECT TO CHANGE WITHOUT NOTICE)  
 THIS DRAWING IS THE PROPERTY OF HUBBELL INC. WIEGMANN  
 ALL INFORMATION IS PROPRIETARY AND NOT TO BE DUPLICATED