

TOP VIEW

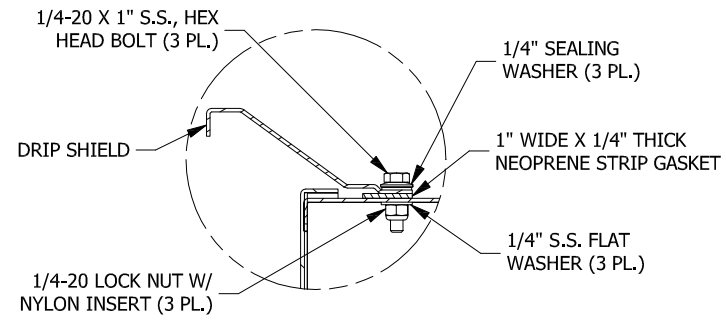

**DETAIL A
(DRIP SHIELD INSTALL DETAIL)**

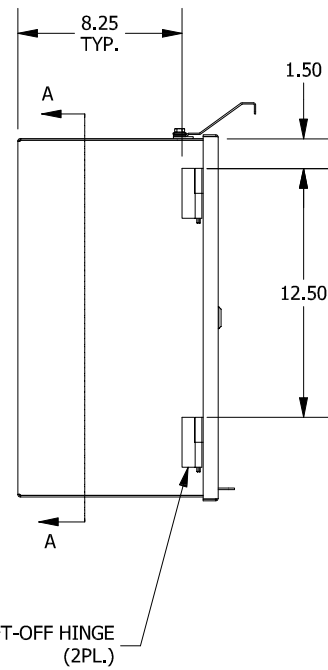
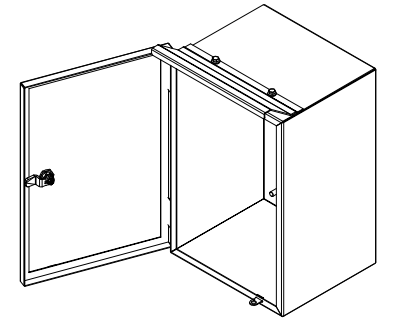

LEFT SIDE VIEW

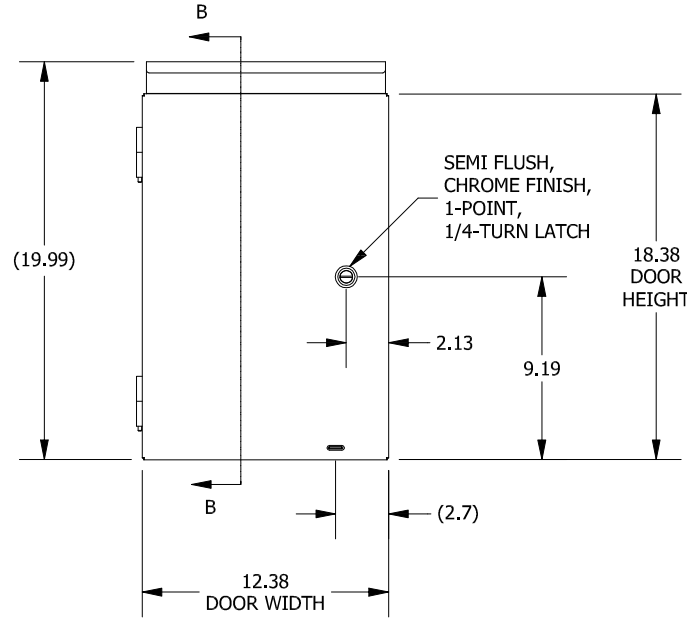

FRONT VIEW

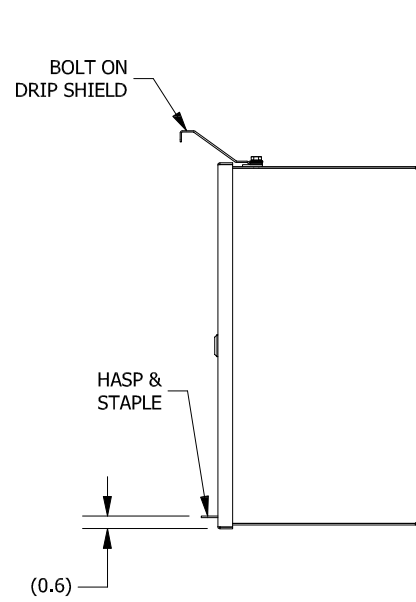

RIGHT SIDE VIEW

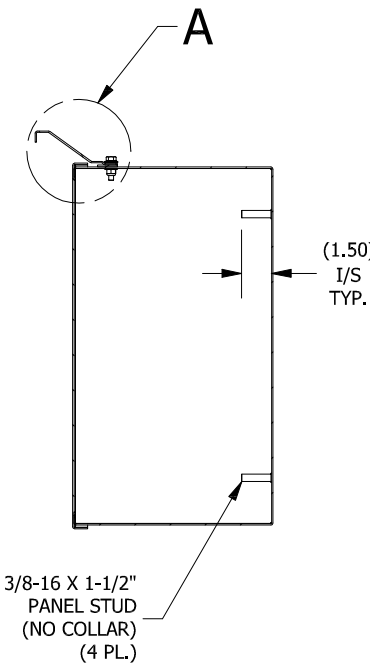

**SECTION B-B
(INSIDE LEFT OF ENCL.)**

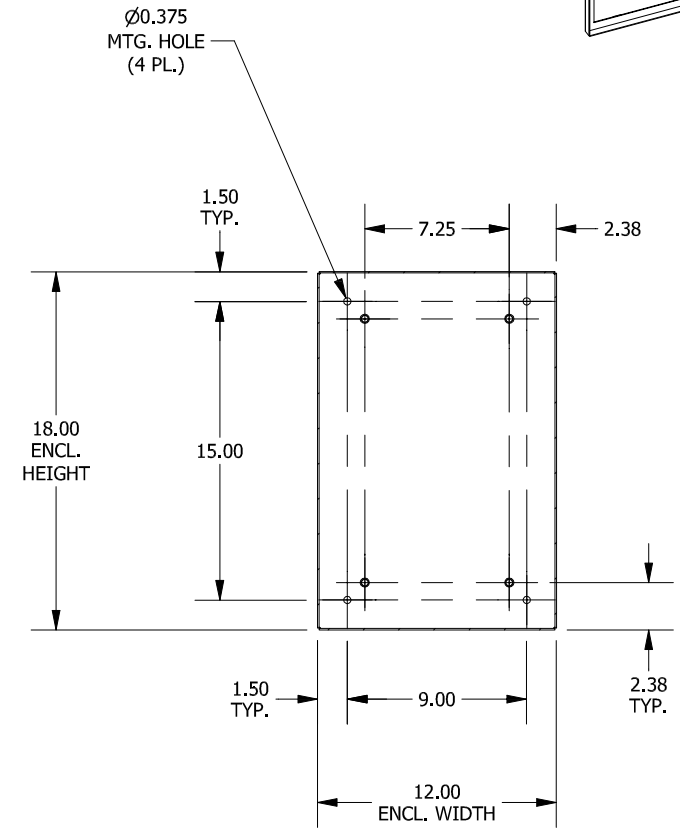

**SECTION A-A
(INSIDE BACK OF ENCL.)**

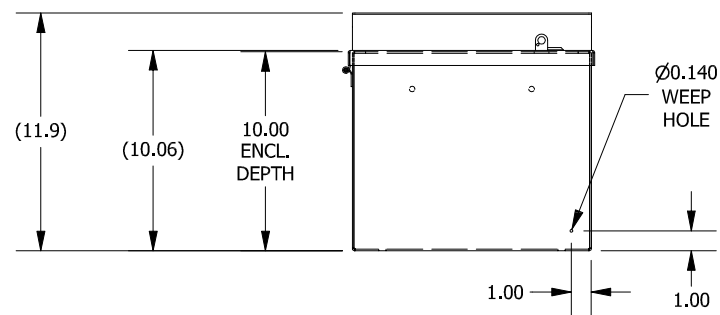

BOTTOM VIEW

PART#: CTSD121810
(DATA SUBJECT TO CHANGE WITHOUT NOTICE)

THIS DRAWING IS PROPERTY OF HUBBELL INC. WIEGMANN
ALL INFORMATION IS PROPRIETARY AND NOT TO BE DUPLICATED