

TOP VIEW

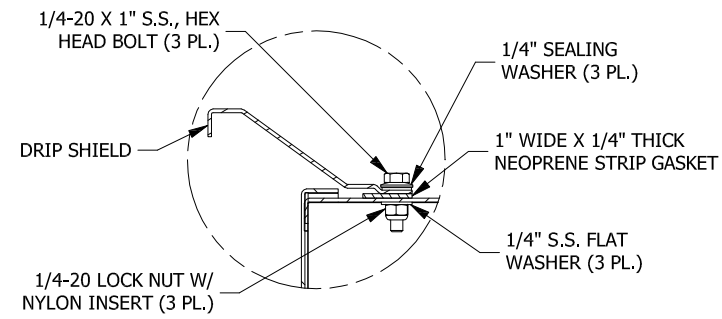

**DETAIL A
(DRIP SHIELD INSTALL DETAIL)**

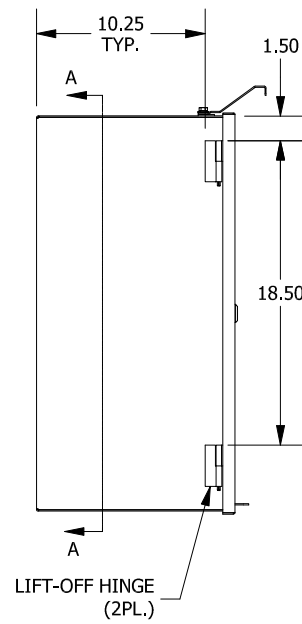
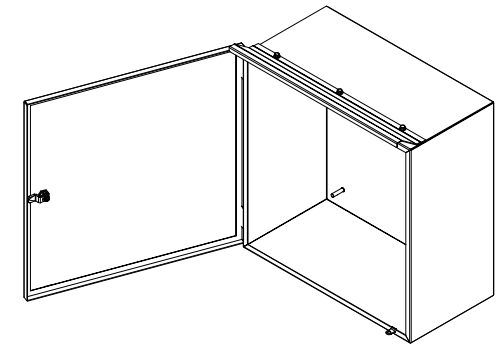

LEFT SIDE VIEW

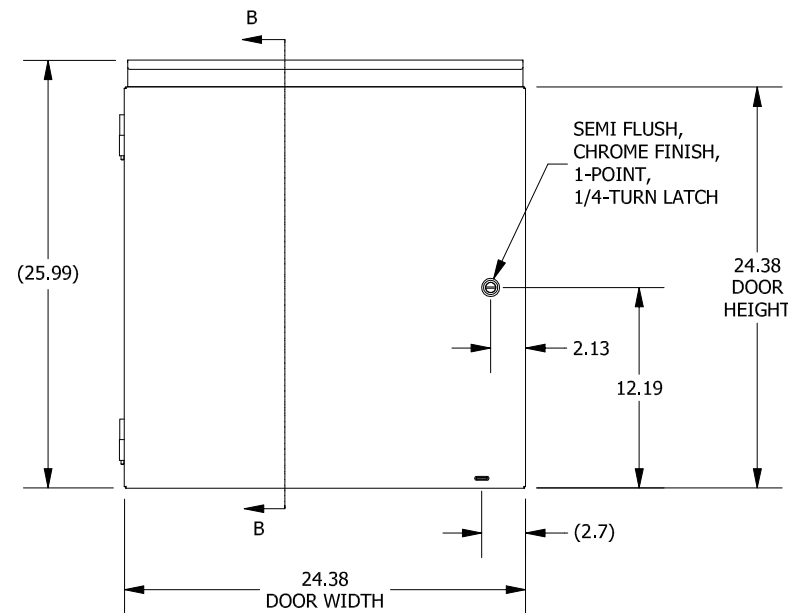

FRONT VIEW

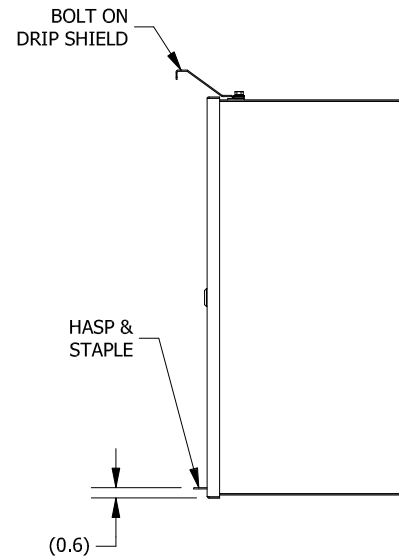

RIGHT SIDE VIEW

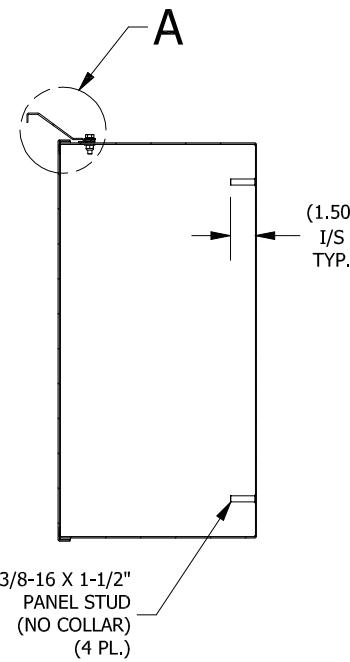

**SECTION B-B
(INSIDE LEFT OF ENCL.)**

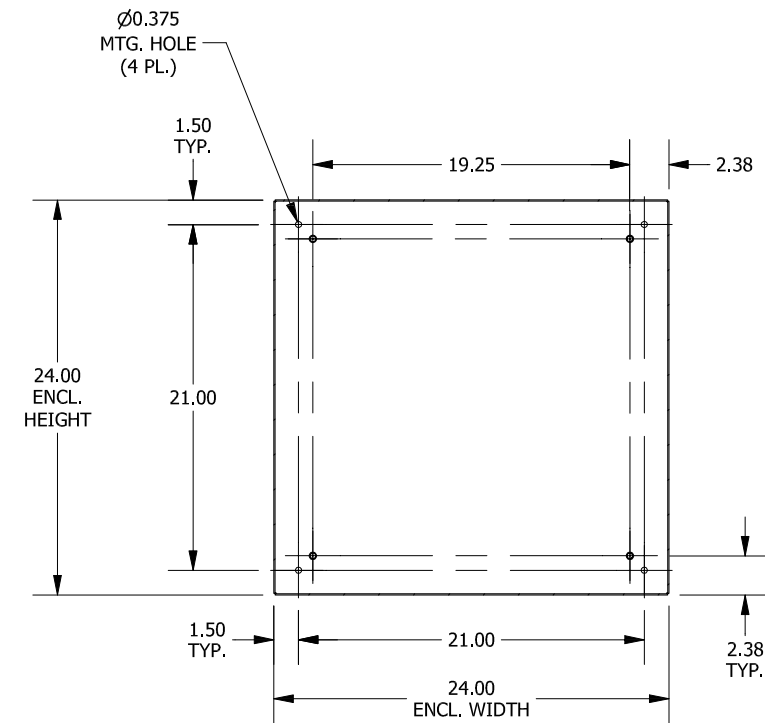

**SECTION A-A
(INSIDE BACK OF ENCL.)**

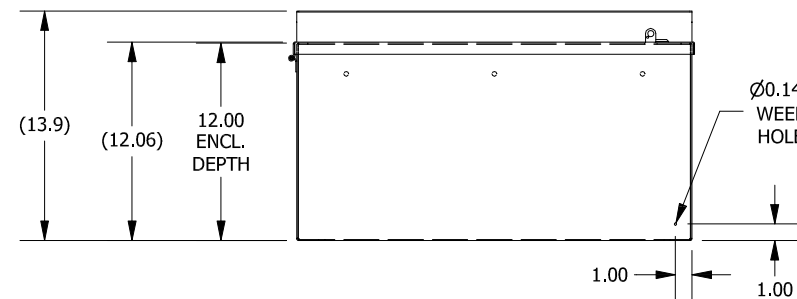
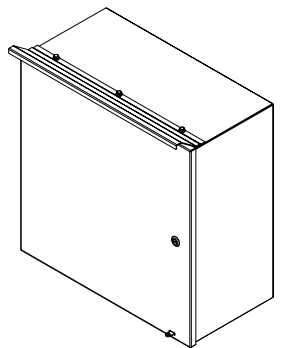

BOTTOM VIEW

PART#: CTSD242412
(DATA SUBJECT TO CHANGE WITHOUT NOTICE)

THIS DRAWING IS PROPERTY OF HUBBELL INC.
WIEGMANN
ALL INFORMATION IS PROPRIETARY AND NOT TO BE
DUPLICATED