

DIMENSIONS

KNHX47	
A	47.00 [1193.8]
B	46.25 [1174.8]
C	45.94 [1166.9]
D	12.25 [311.2]
E	11.25 [285.8]
F	27.38 [695.5]
G	2.50 [63.5]
H	4.00 [101.6]
J	8
K	33

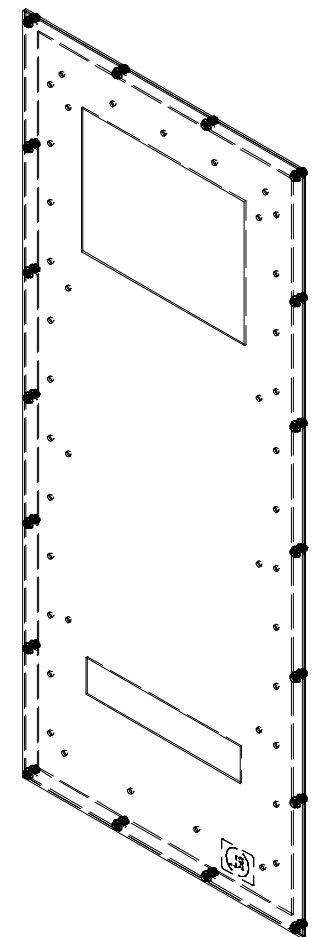
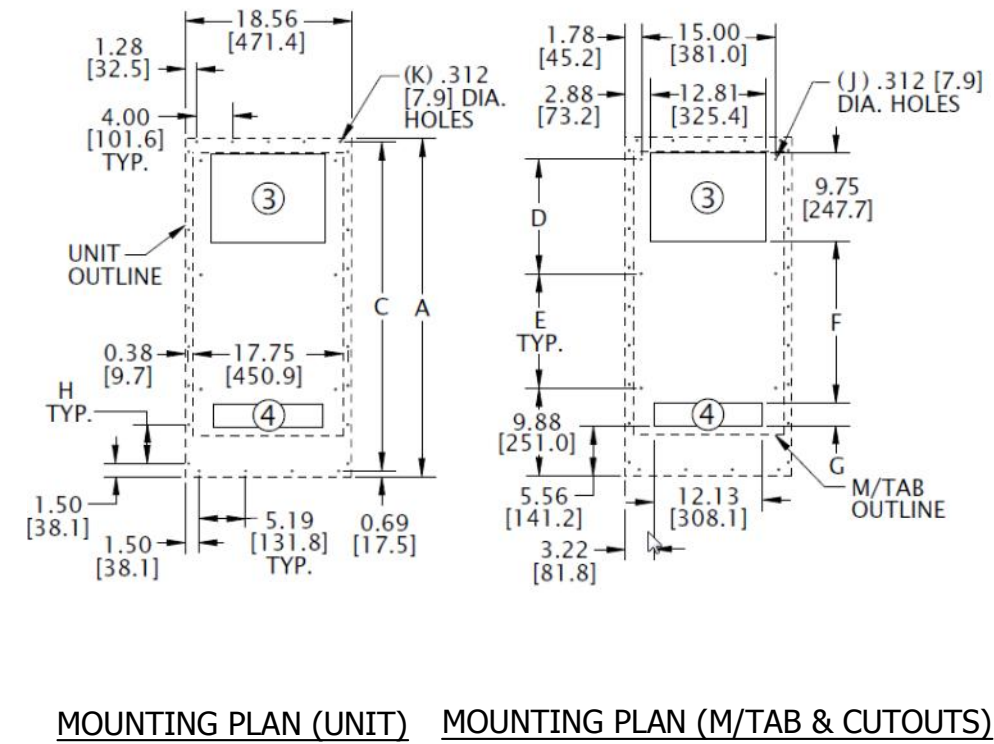
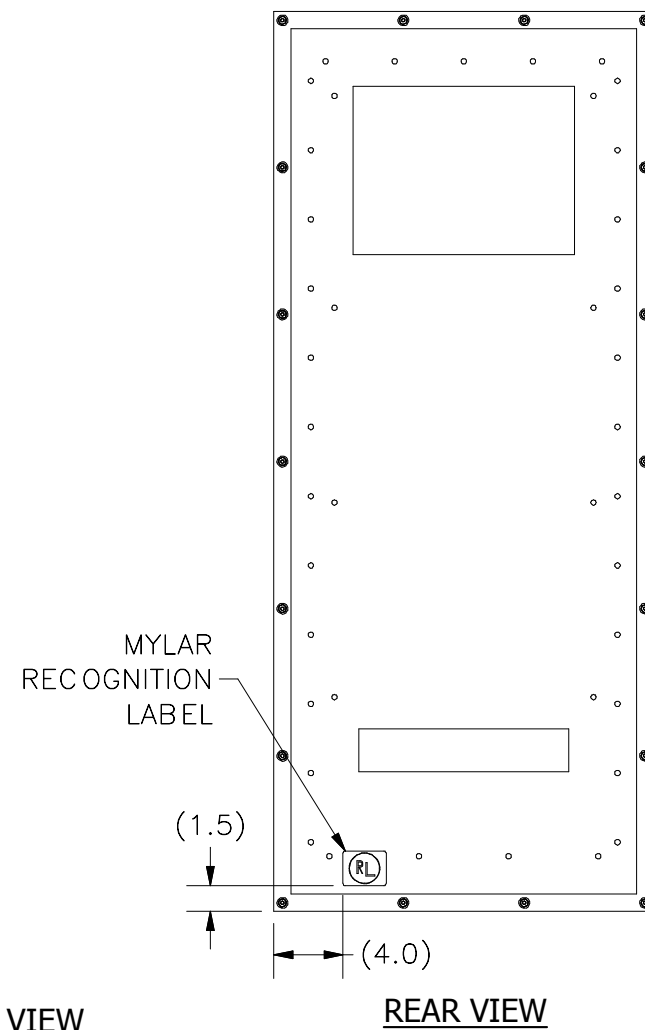
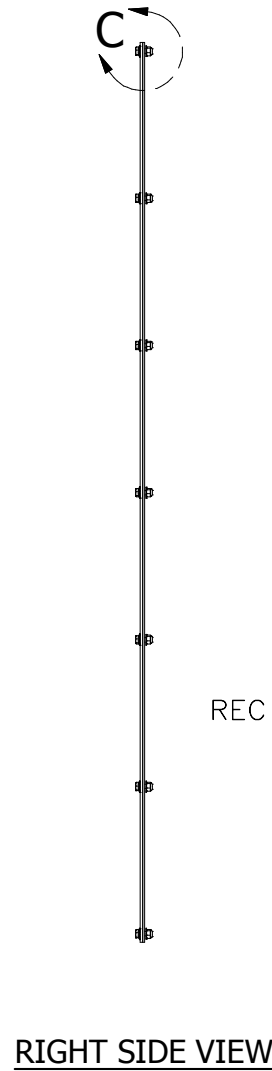
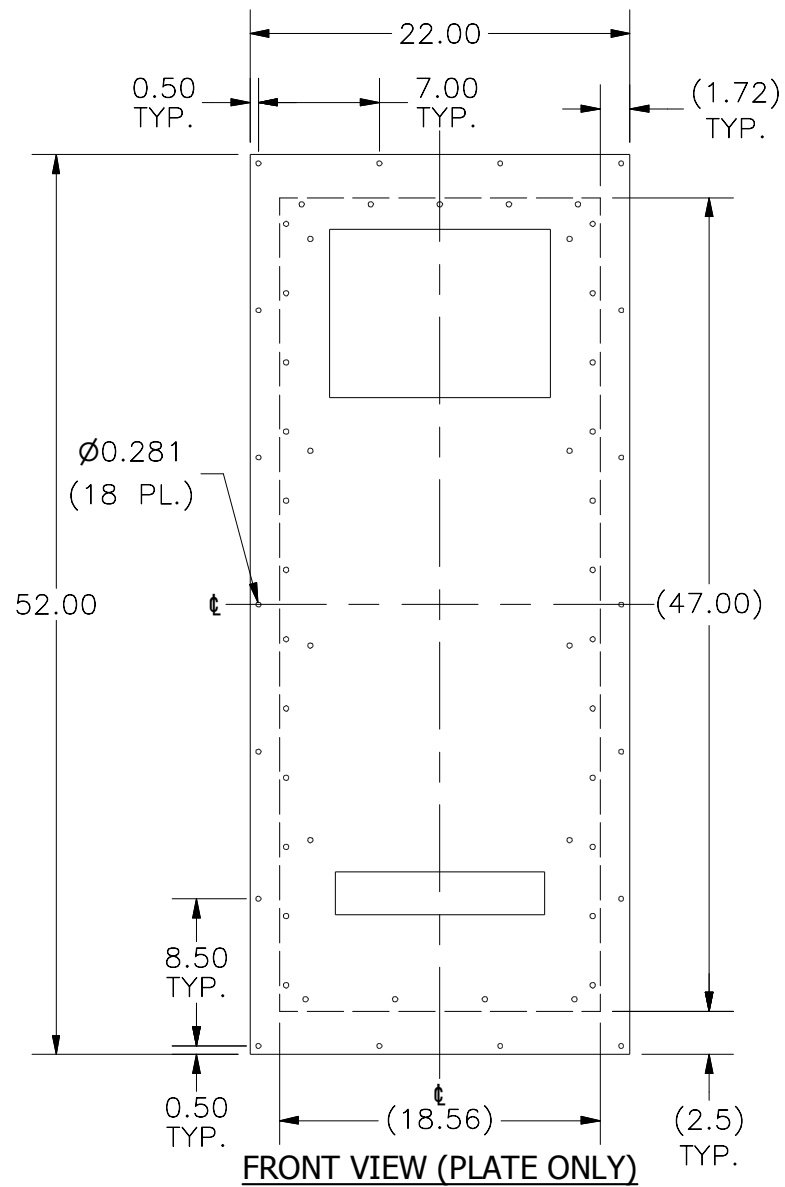

PART#: D52CVPKNHX47
(DATA SUBJECT TO CHANGE WITHOUT NOTICE)