

TOP VIEW

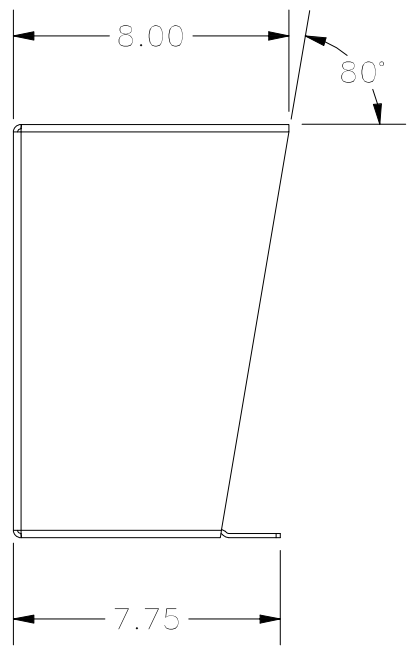

LEFT VIEW

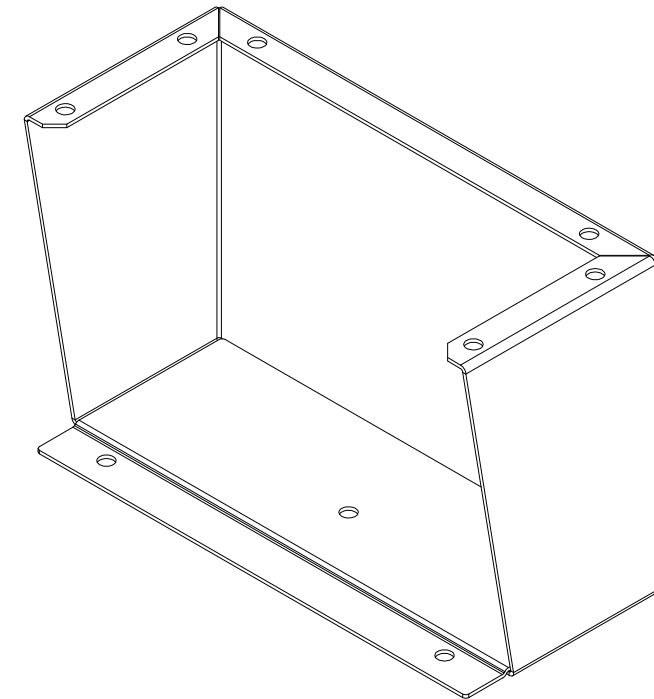
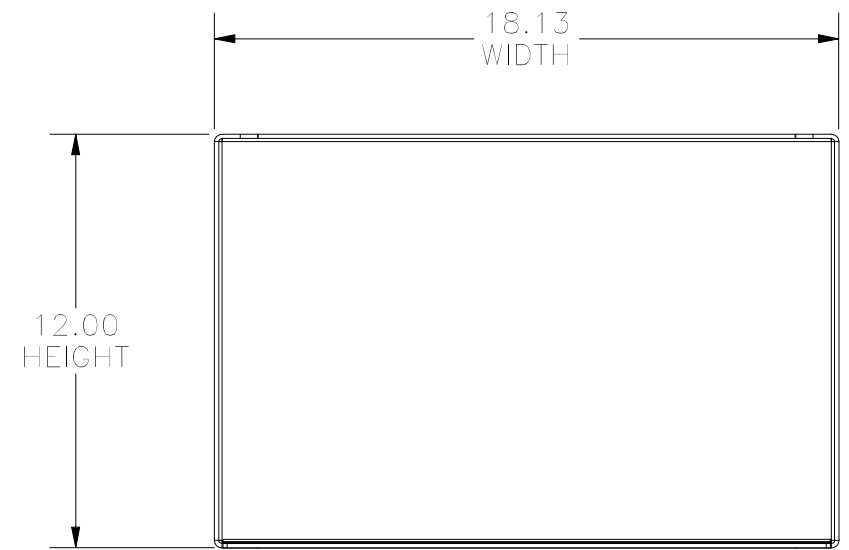

FRONT VIEW

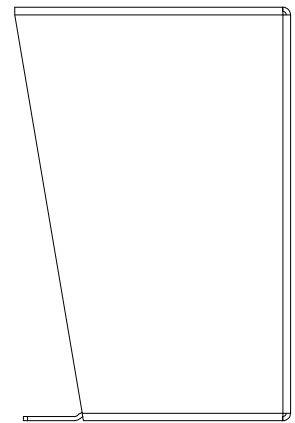

RIGHT VIEW

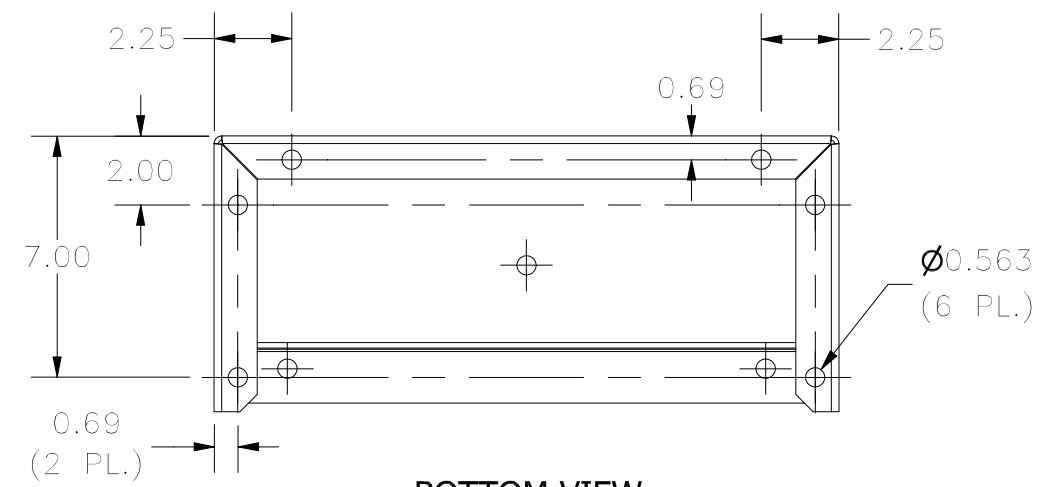

BOTTOM VIEW

PART#: FK1218
 (DATA SUBJECT TO CHANGE WITHOUT NOTICE)