

TOP VIEW

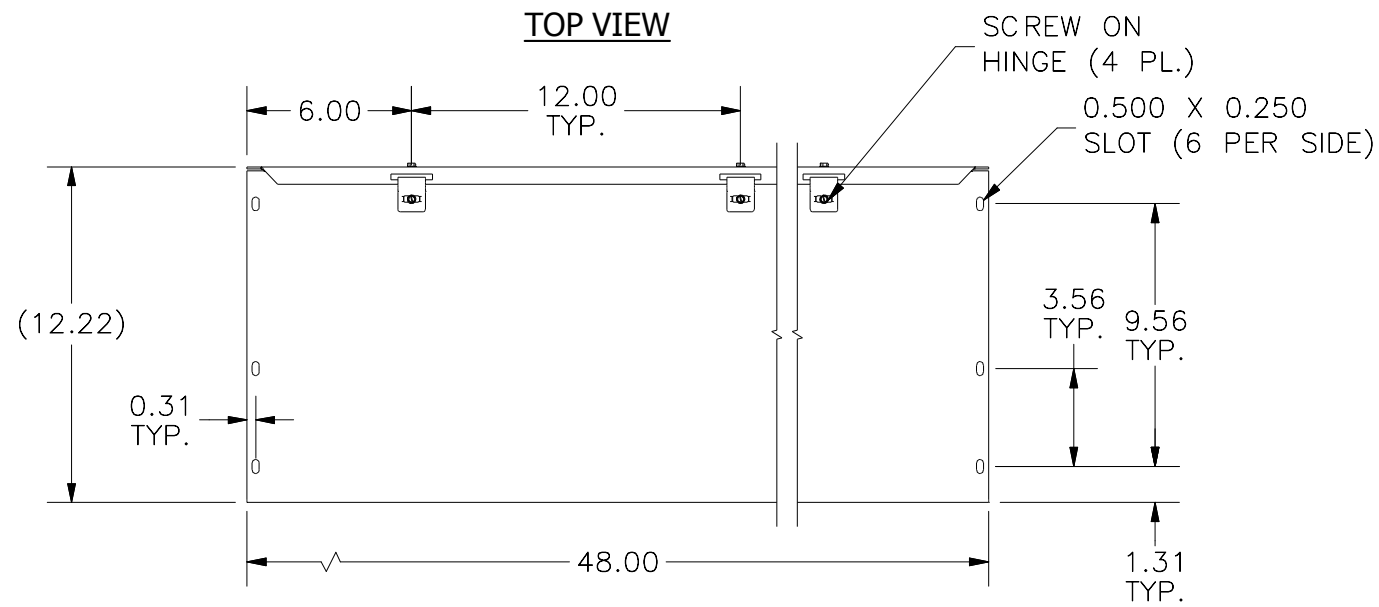

FRONT VIEW

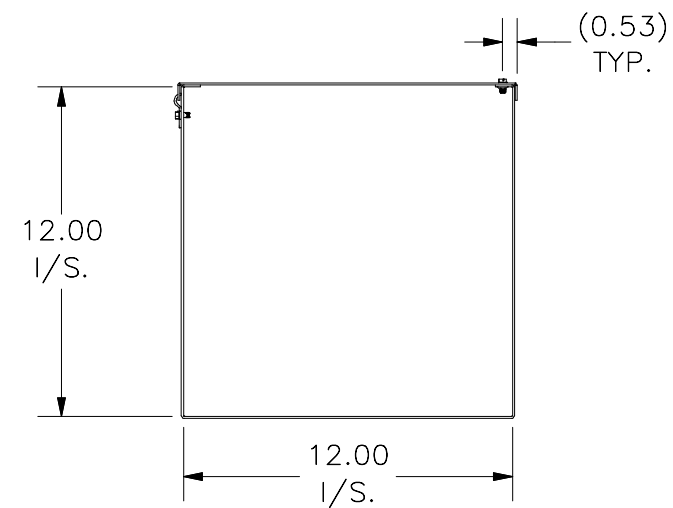

RIGHT VIEW

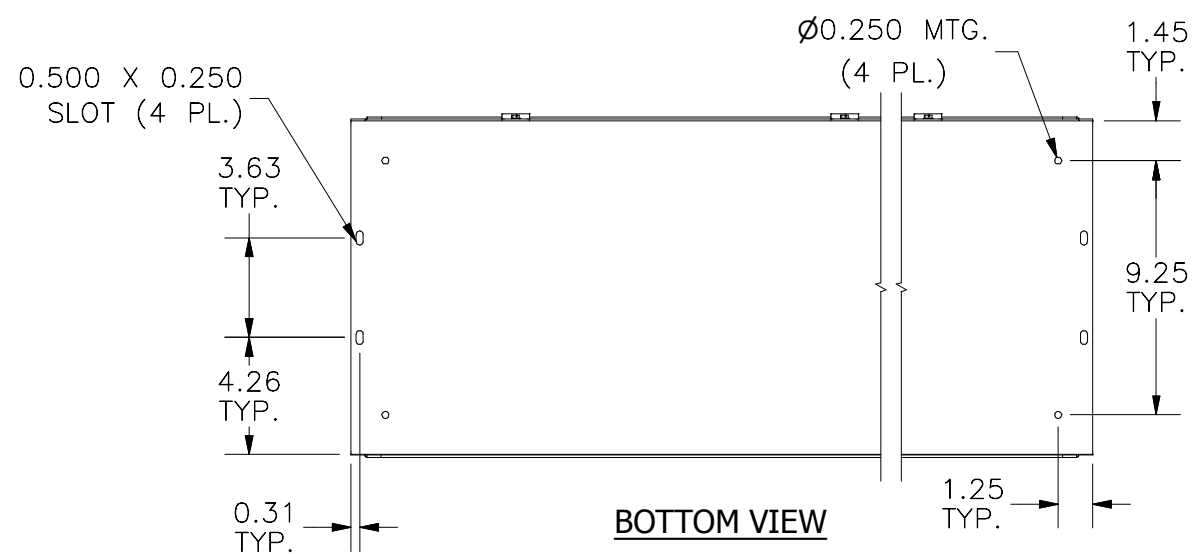
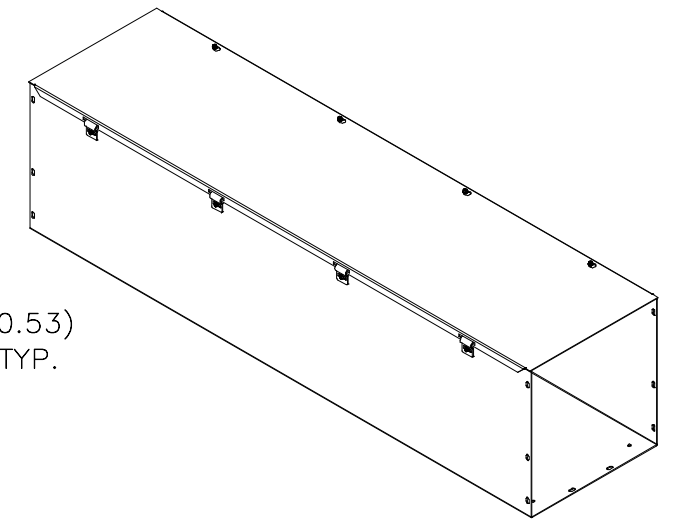

BOTTOM VIEW

PART#: HS12124NK  
(DATA SUBJECT TO CHANGE WITHOUT NOTICE)

THIS DRAWING IS PROPERTY OF HUBBELL INC. WIEGMANN  
ALL INFORMATION IS PROPRIETARY AND NOT TO BE DUPLICATED