

TOP VIEW

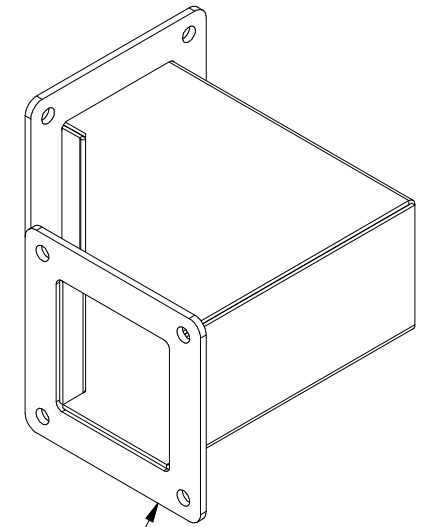

10 GA. C.R.S. WELDED  
ON RING (2 PL.)

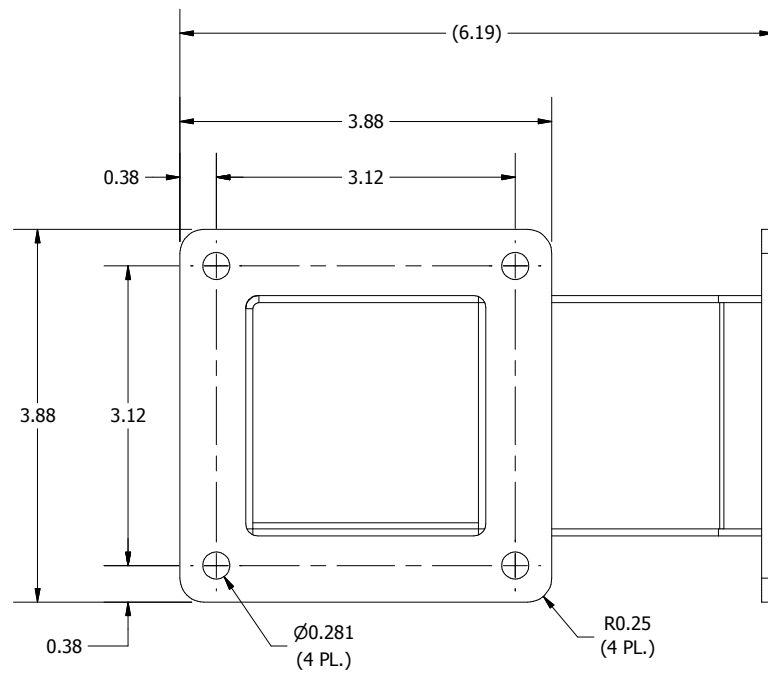

RIGHT SIDE VIEW

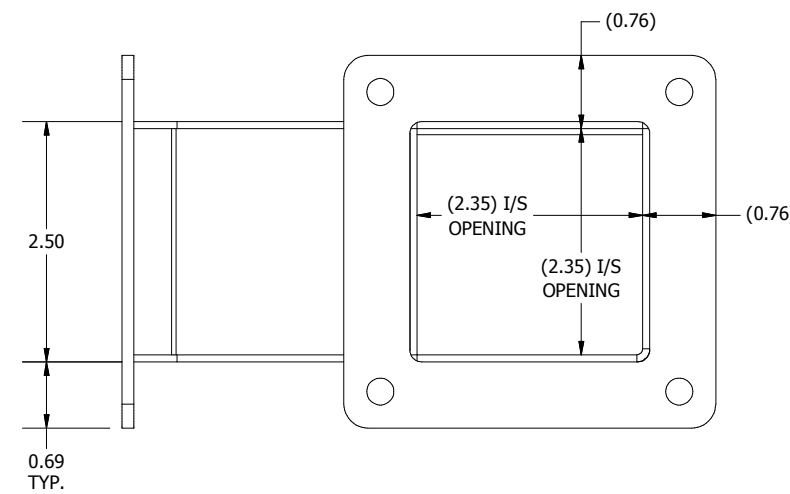

FRONT VIEW

**PART#: JWL902**  
**(DATA SUBJECT TO CHANGE WITHOUT NOTICE)**

THIS DRAWING IS PROPERTY OF HUBBELL INC. WIEGMANN  
ALL INFORMATION IS PROPRIETARY AND NOT TO BE DUPLICATED