

LEFT SIDE VIEW

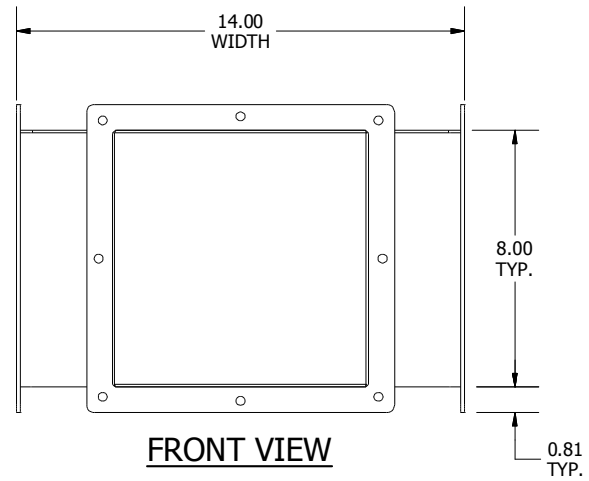

FRONT VIEW

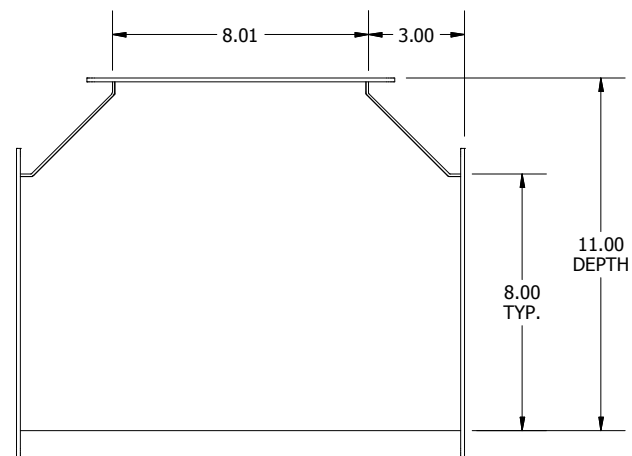
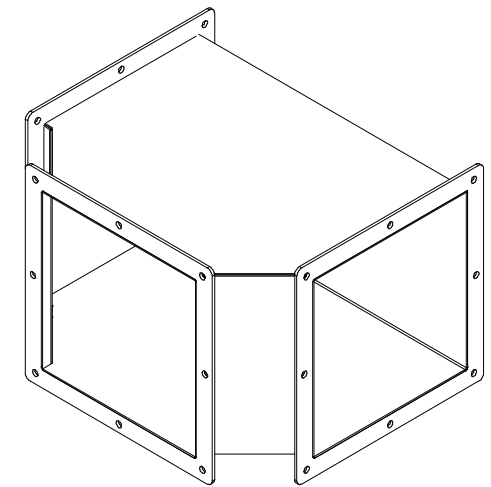

BOTTOM VIEW

PART#: JWT8
 (DATA SUBJECT TO CHANGE WITHOUT NOTICE)

THIS DRAWING IS PROPERTY OF HUBBELL INC. WIEGMANN
 ALL INFORMATION IS PROPRIETARY AND NOT TO BE DUPLICATED