

**TOP VIEW**

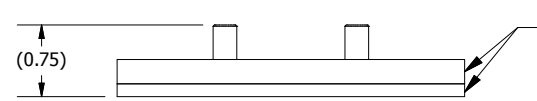

ALIGN SIDES OF GASKET WITH SIDE OF BOTTOM PIECE

**BOTTOM ASSEMBLY FRONT VIEW**

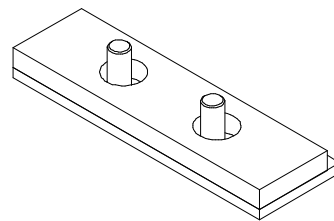
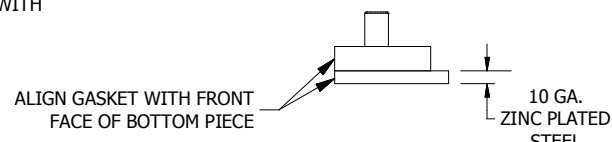

ALIGN GASKET WITH FRONT FACE OF BOTTOM PIECE

**SIDE VIEW**

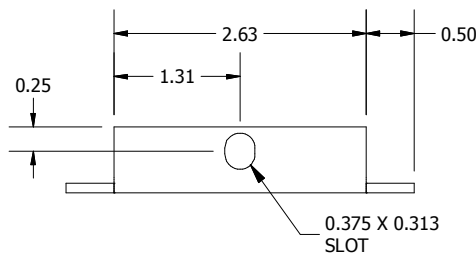

**TOP PIECE FRONT VIEW**

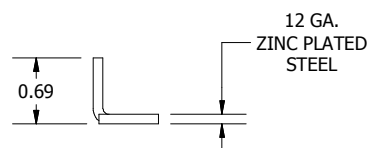

**SIDE VIEW**

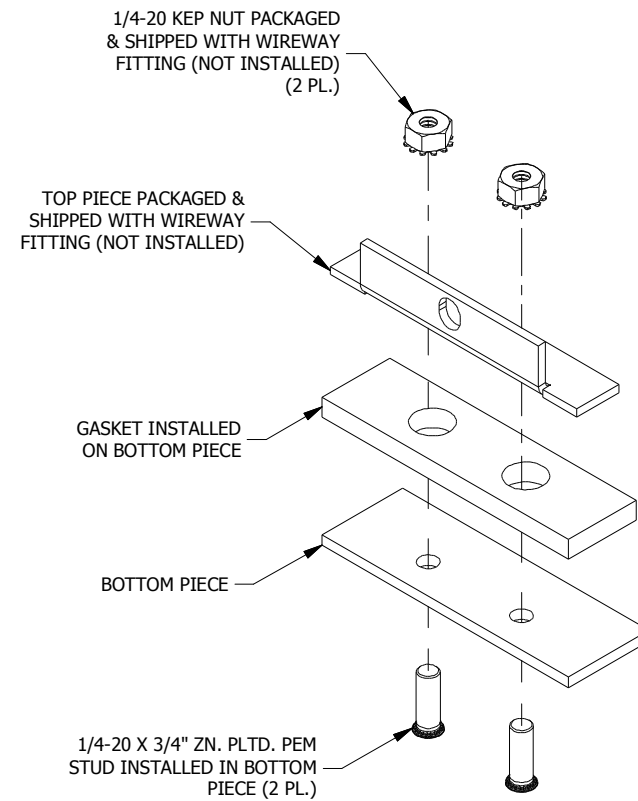

**ASSEMBLY EXPLODED VIEW**

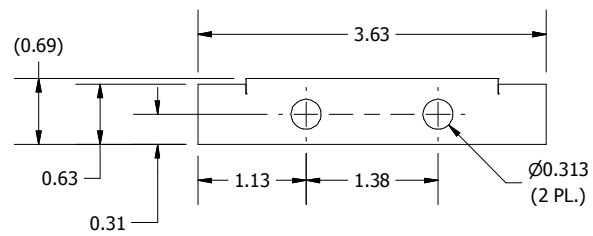

**BOTTOM VIEW**

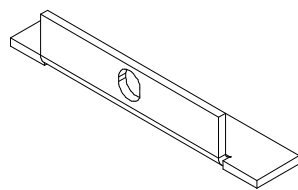

PART#: LJW4ASP  
 (DATA SUBJECT TO CHANGE WITHOUT NOTICE)

THIS DRAWING IS PROPERTY OF HUBBELL INC. WIEGMANN  
 ALL INFORMATION IS PROPRIETARY AND NOT TO BE DUPLICATED