

TOP VIEW

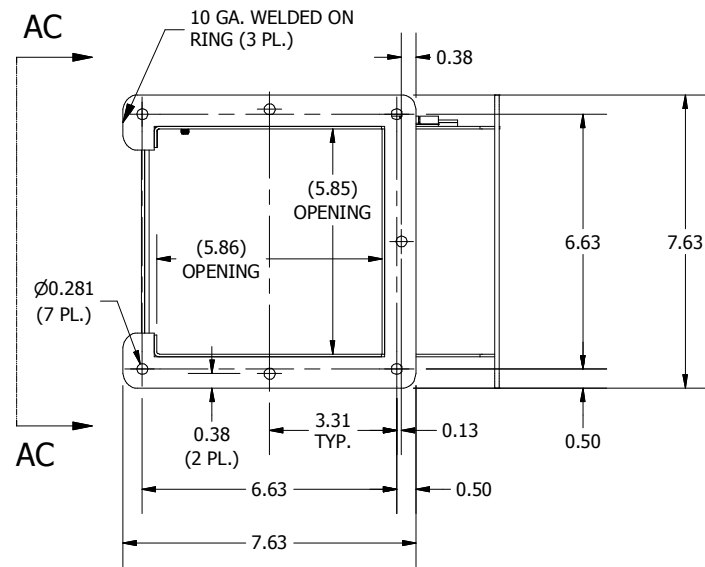

LEFT SIDE VIEW

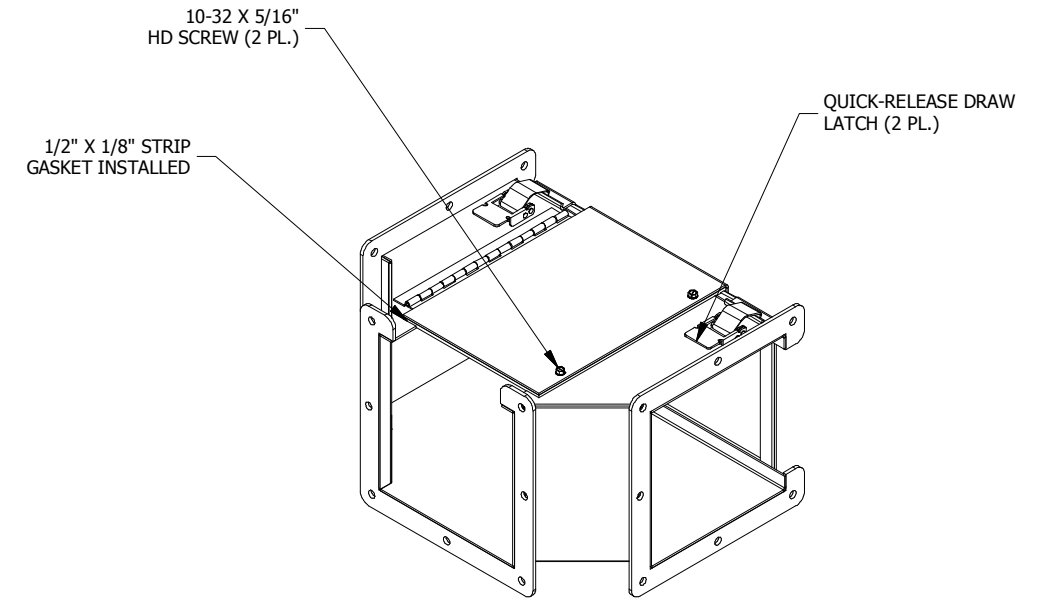
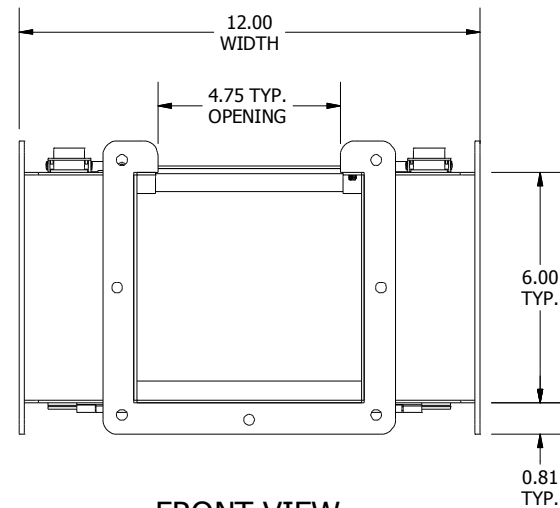

FRONT VIEW

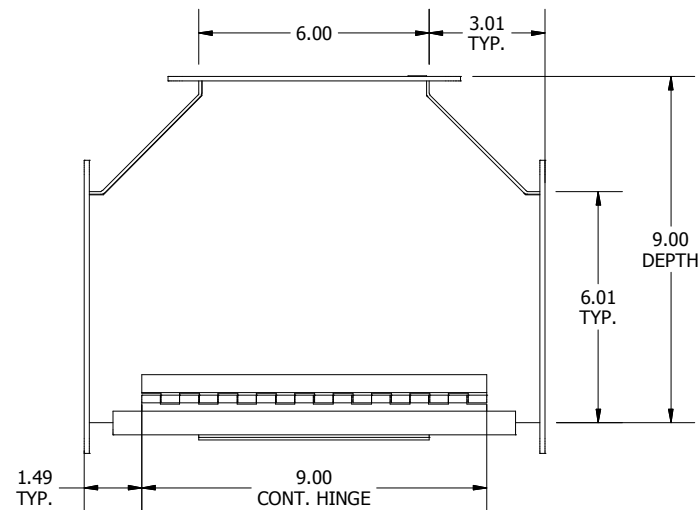

BOTTOM VIEW

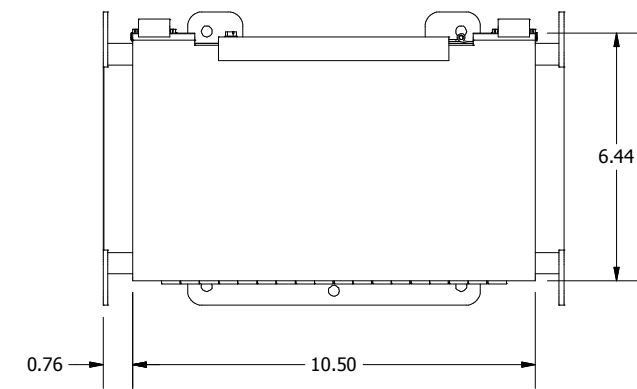

**VIEW AC-AC
(BACK LID VIEW)**

PART#: LJWT6C
(DATA SUBJECT TO CHANGE WITHOUT NOTICE)

THIS DRAWING IS PROPERTY OF HUBBELL INC. WIEGMANN
ALL INFORMATION IS PROPRIETARY AND NOT TO BE DUPLICATED