

LEFT SIDE

FRONT VIEW

RIGHT VIEW

SECTION A-A

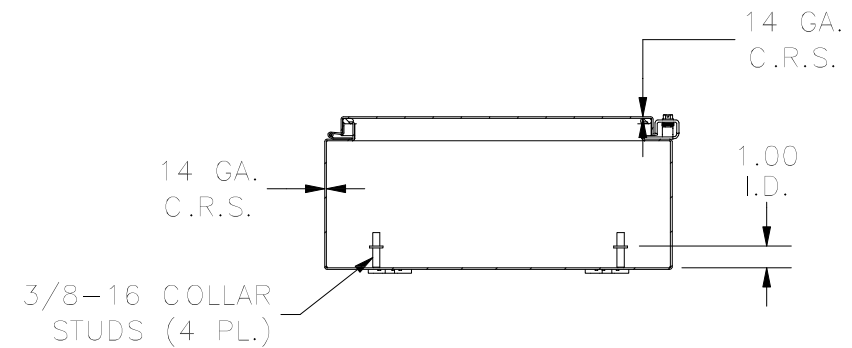
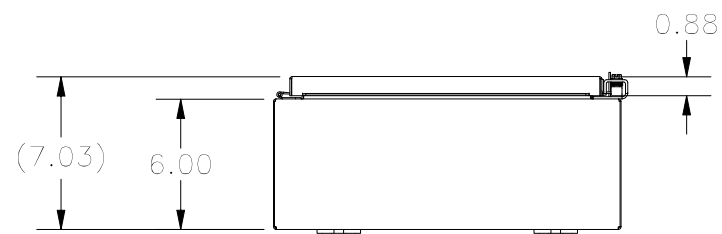

BOTTOM VIEW

SECTION B-B

PART#: N12201606
 (DATA SUBJECT TO CHANGE WITHOUT NOTICE)

THIS DRAWING IS PROPERTY OF HUBBELL INC. WIEGMANN
 ALL INFORMATION IS PROPRIETARY AND NOT TO BE DUPLICATED