

TOP VIEW

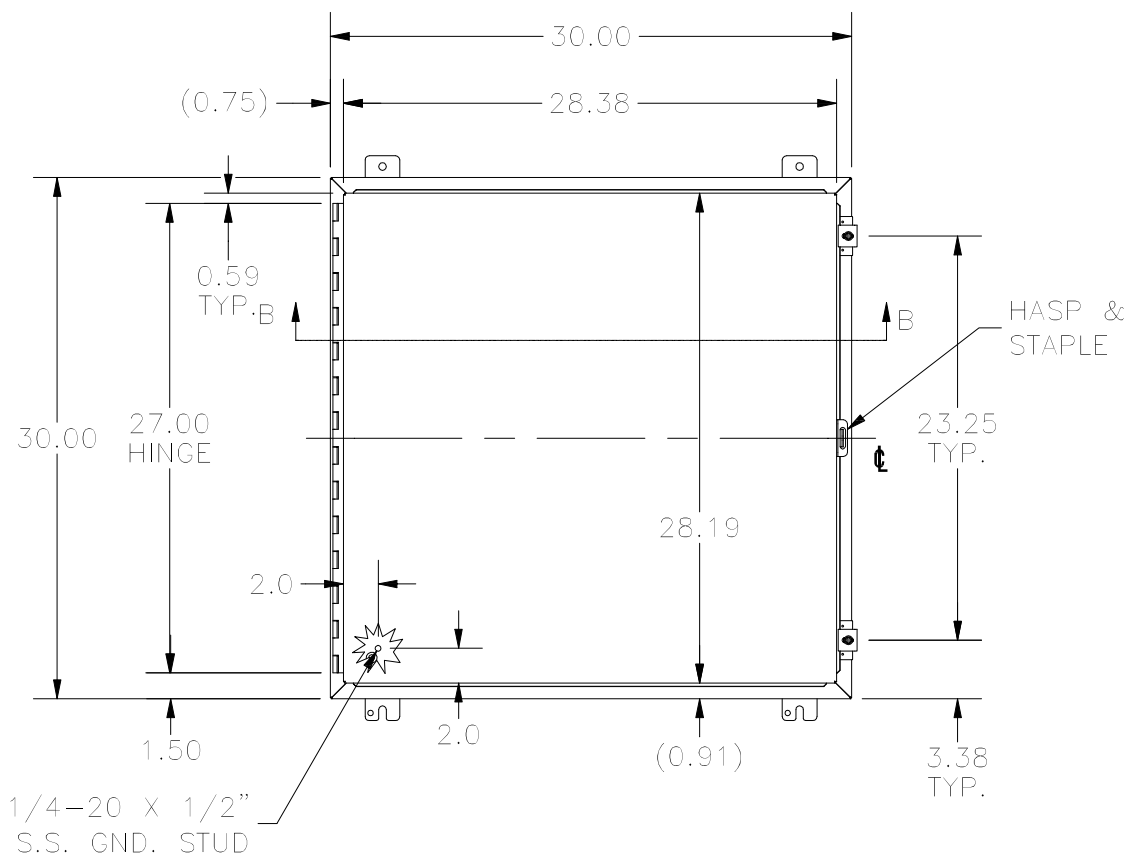

FRONT VIEW

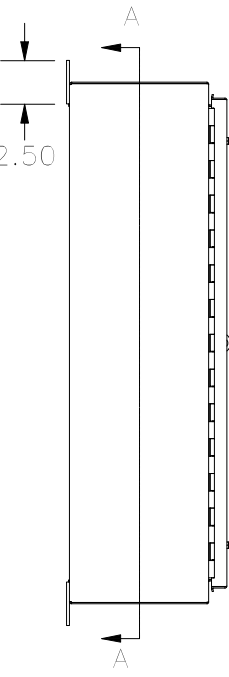

LEFT SIDE

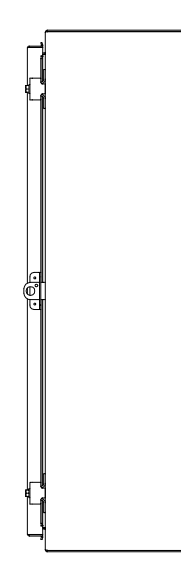

RIGHT VIEW

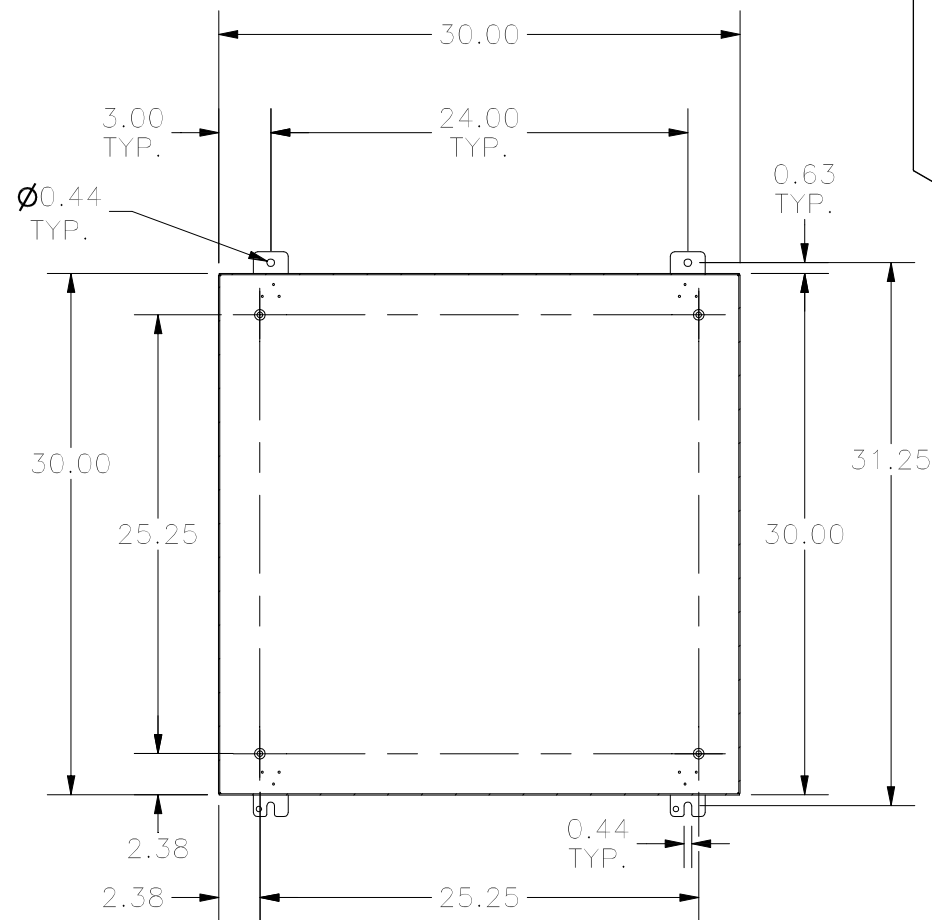

SECTION A-A

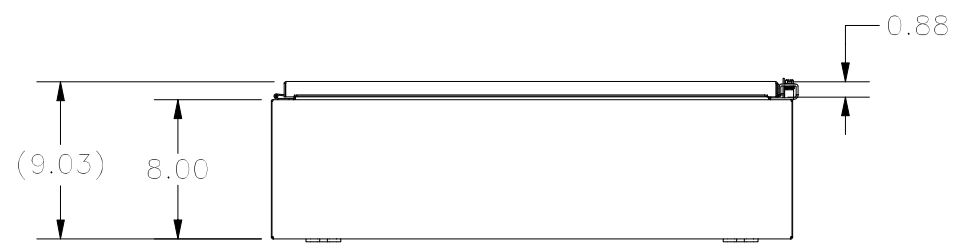

BOTTOM VIEW

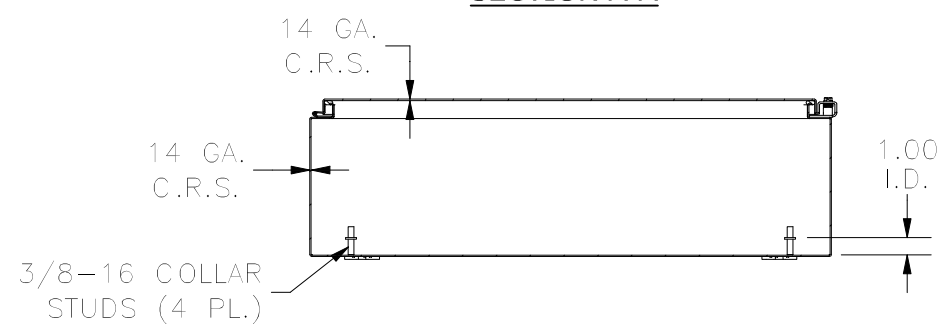

SECTION B-B

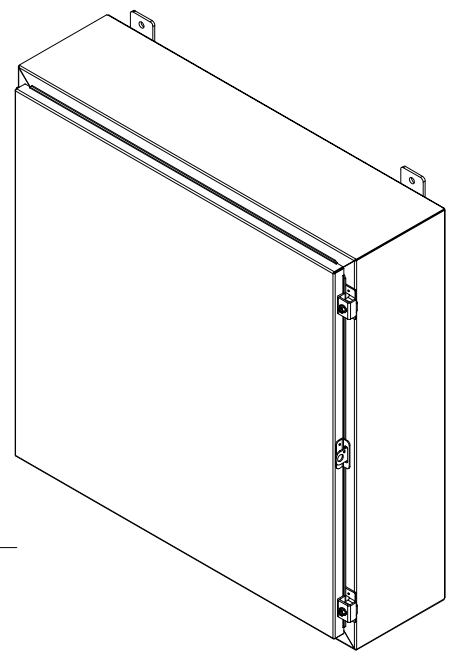

PART#: N12303008
(DATA SUBJECT TO CHANGE WITHOUT NOTICE)

THIS DRAWING IS PROPERTY OF HUBBELL INC. WIEGMANN
ALL INFORMATION IS PROPRIETARY AND NOT TO BE DUPLICATED