

TOP VIEW

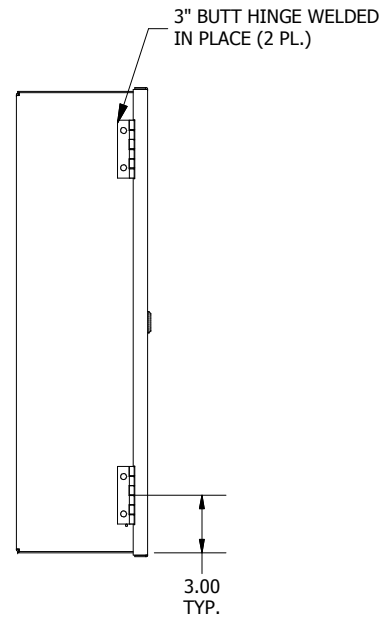

LEFT SIDE VIEW

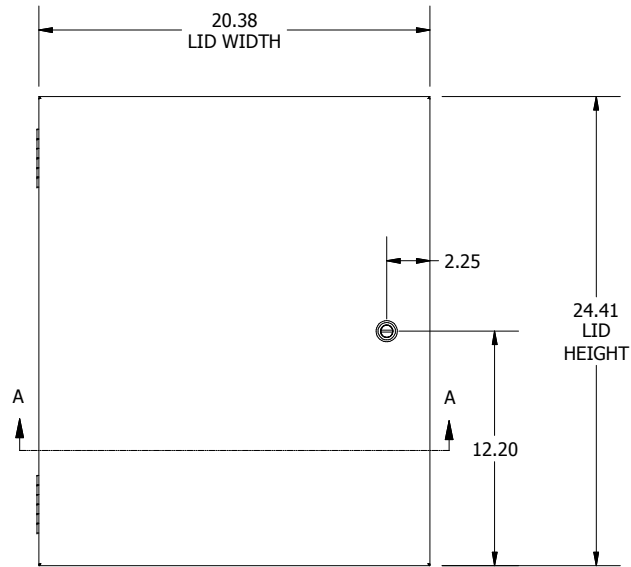

FRONT VIEW

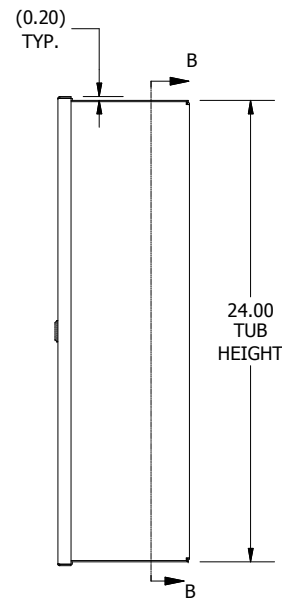

RIGHT SIDE VIEW

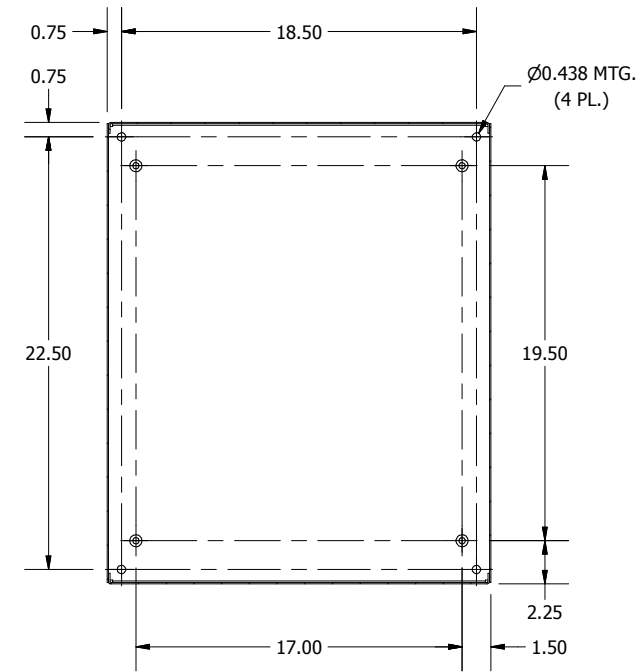

SECTION B-B  
(INSIDE BACK OF ENCL.)

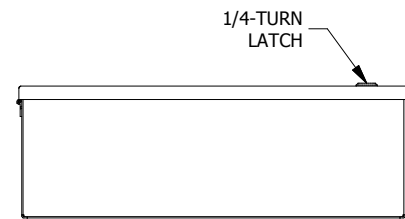

BOTTOM VIEW

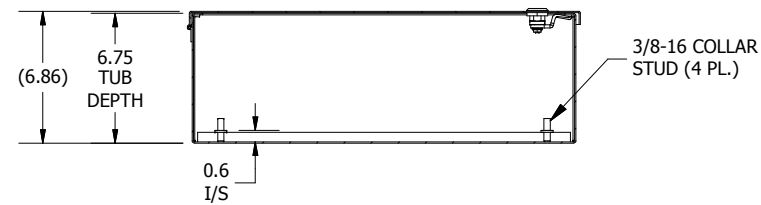

SECTION A-A  
(INSIDE TOP OF ENCL.)

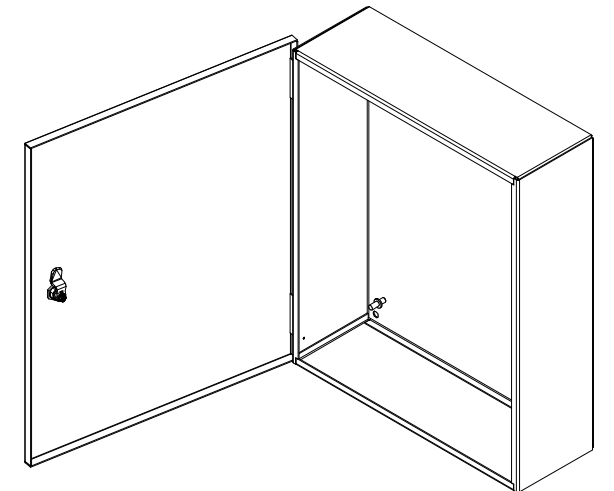
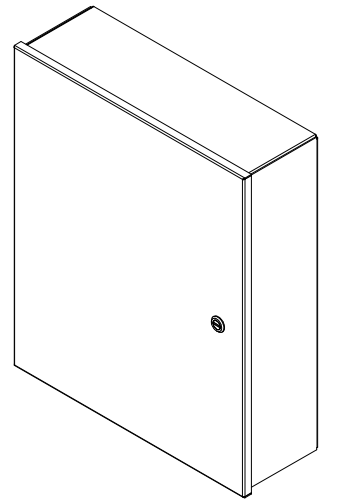

**PART#: HWDN1C202406LP**  
**(DATA SUBJECT TO CHANGE WITHOUT NOTICE)**

THIS DRAWING IS PROPERTY OF HUBBELL INC. WIEGMANN  
ALL INFORMATION IS PROPRIETARY AND NOT TO BE DUPLICATED