

**TOP VIEW**

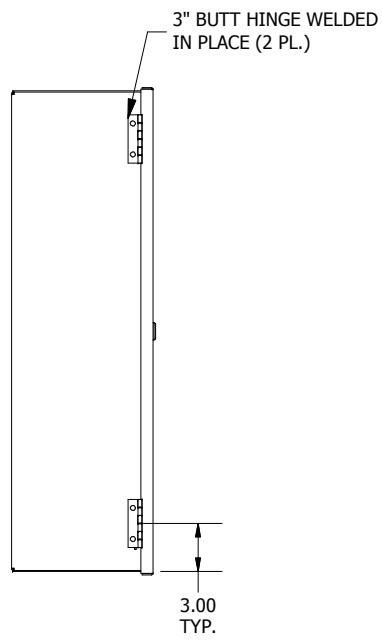

**LEFT SIDE VIEW**

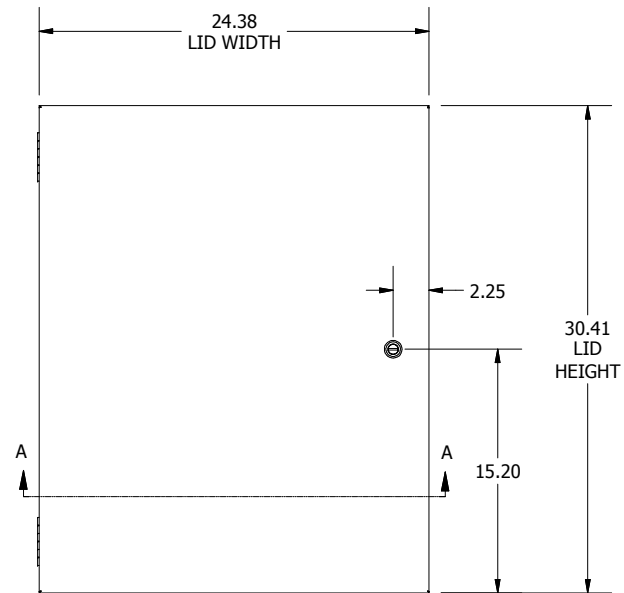

**FRONT VIEW**

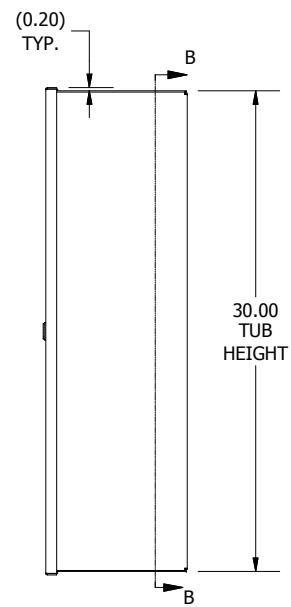

**RIGHT SIDE VIEW**

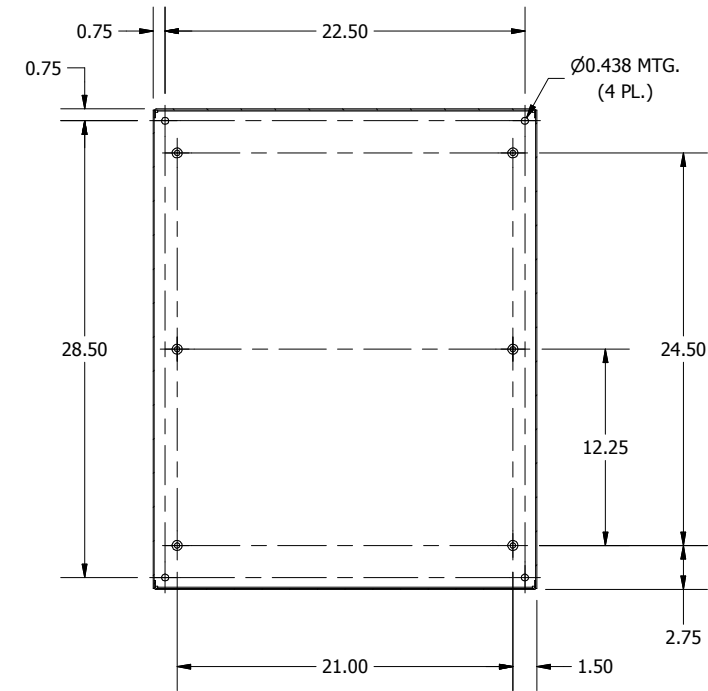

**SECTION B-B  
(INSIDE BACK OF ENCL.)**

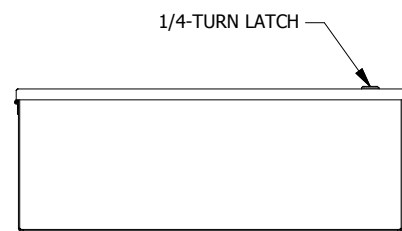

**BOTTOM VIEW**

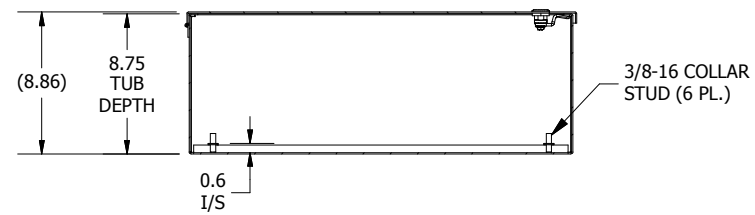

**SECTION A-A  
(INSIDE TOP OF ENCL.)**

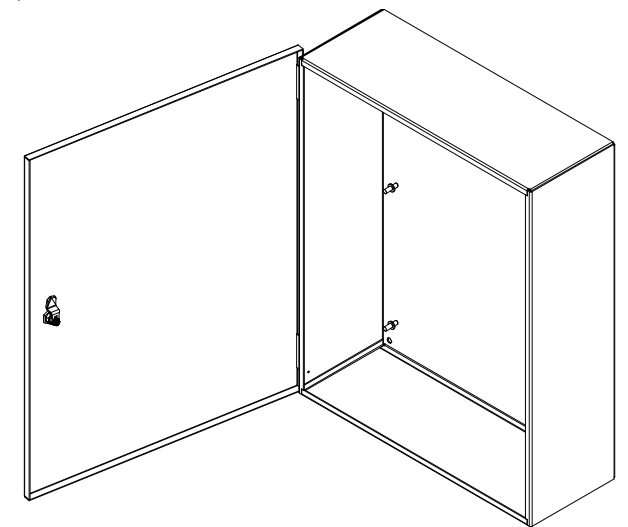
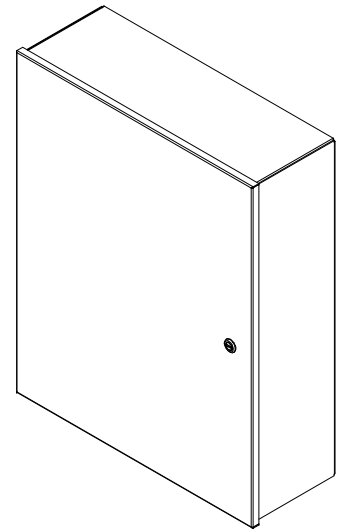

**PART#: HWDN1C243008LP  
(DATA SUBJECT TO CHANGE WITHOUT NOTICE)**

THIS DRAWING IS PROPERTY OF HUBBELL INC. WIEGMANN  
ALL INFORMATION IS PROPRIETARY AND NOT TO BE DUPLICATED