

TOP VIEW

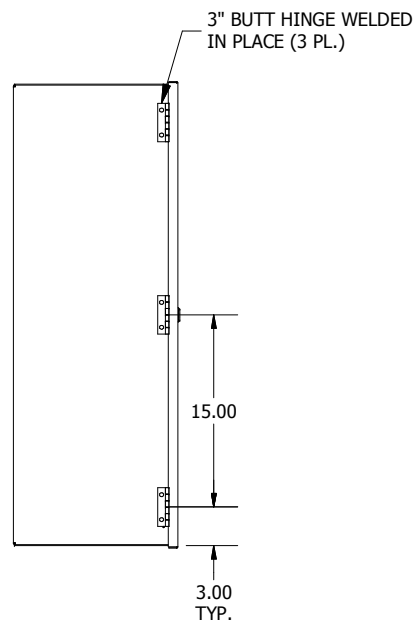

LEFT SIDE VIEW

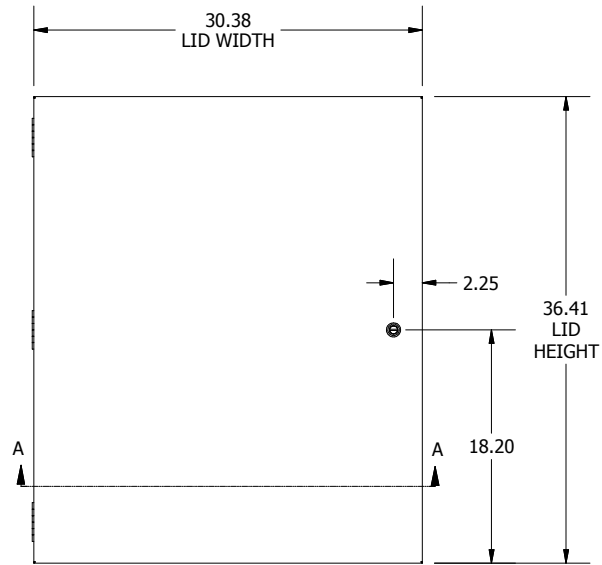

FRONT VIEW

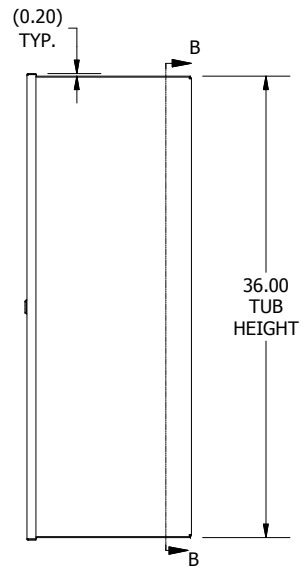

RIGHT SIDE VIEW

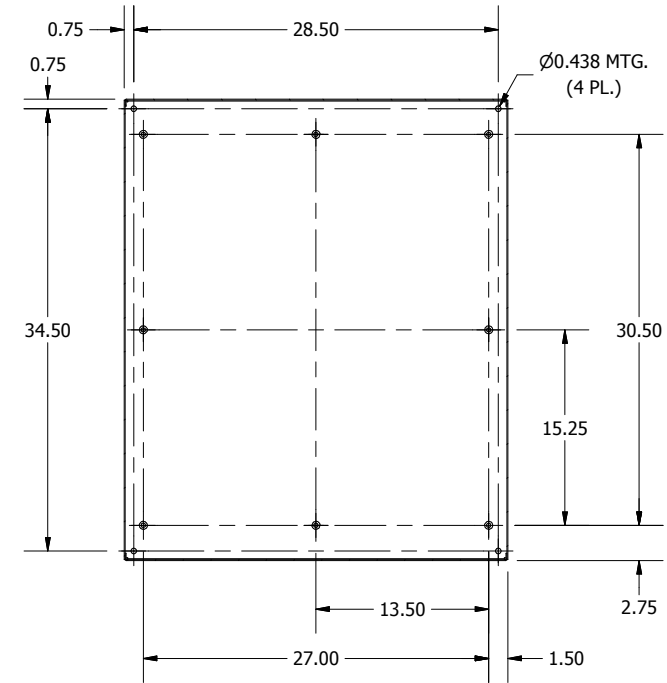

**SECTION B-B
(INSIDE BACK OF ENCL.)**

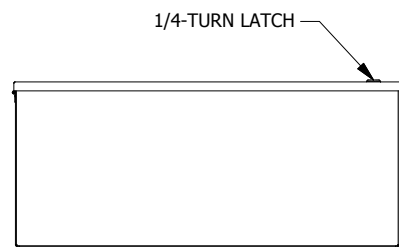

BOTTOM VIEW

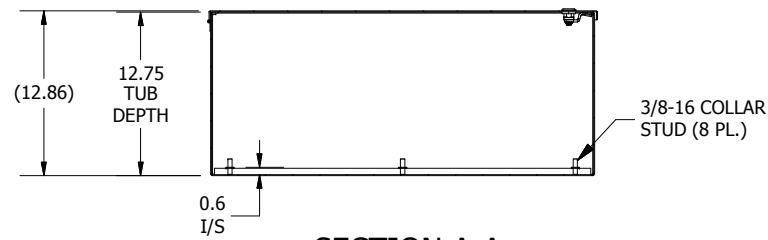

**SECTION A-A
(INSIDE TOP OF ENCL.)**

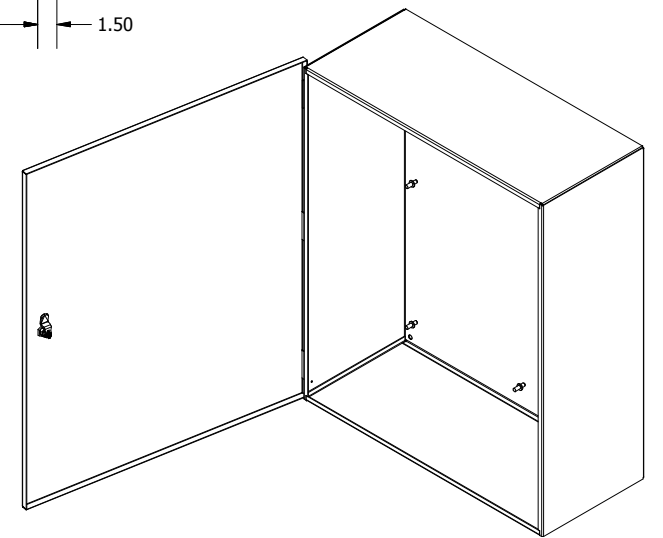
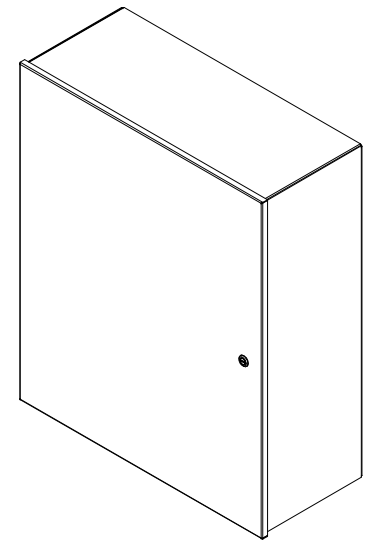

**PART#: HWDN1C303612LP
(DATA SUBJECT TO CHANGE WITHOUT NOTICE)**

THIS DRAWING IS PROPERTY OF HUBBELL INC. WIEGMANN
ALL INFORMATION IS PROPRIETARY AND NOT TO BE DUPLICATED