

TOP VIEW

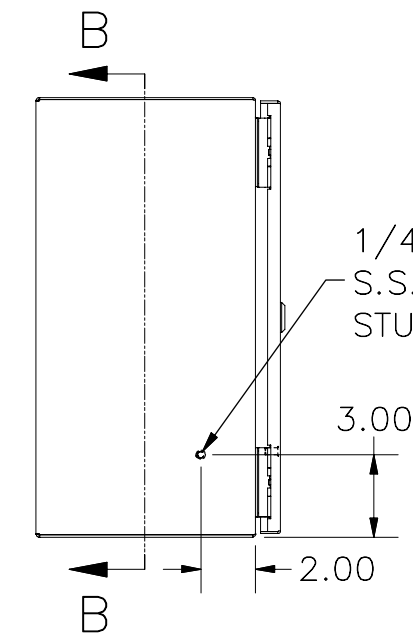

LEFT SIDE VIEW

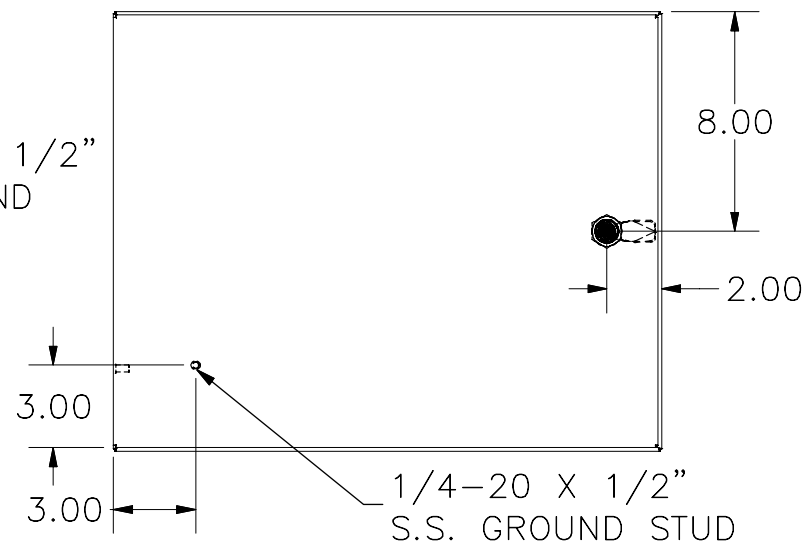

FRONT VIEW

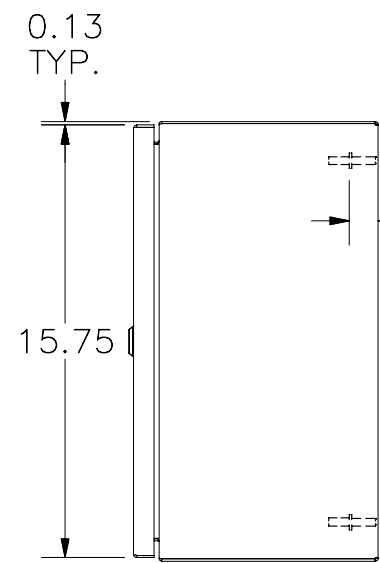

RIGHT SIDE VIEW

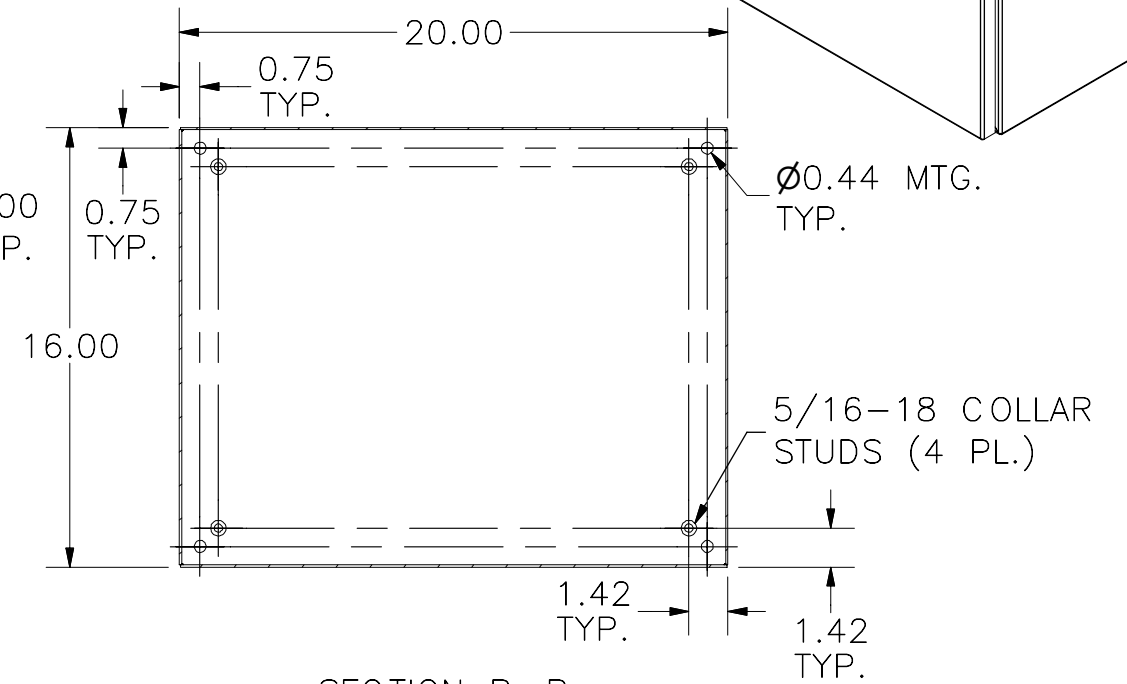

SECTION B-B
(INSIDE BACK OF ENCLOSURE)

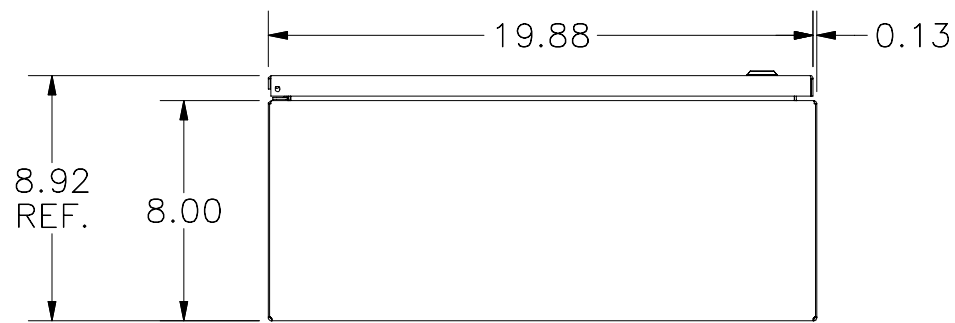

BOTTOM VIEW

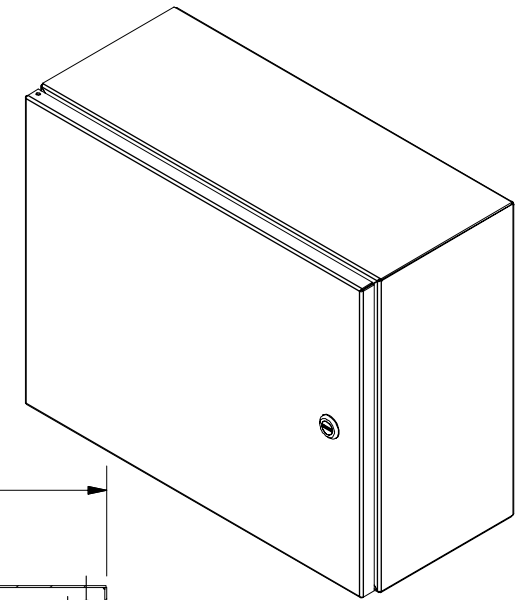

PART#: N412162008CLG
(DATA SUBJECT TO CHANGE WITHOUT NOTICE)