

TOP VIEW

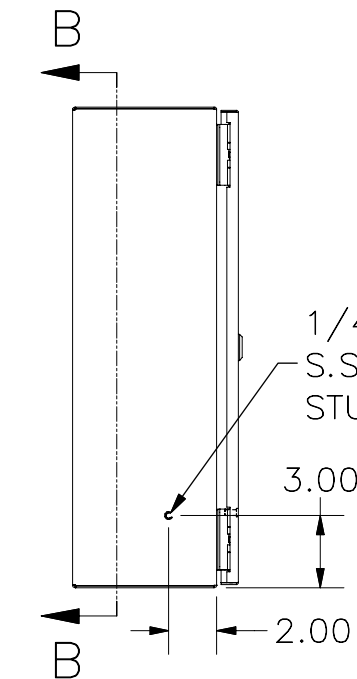

LEFT SIDE VIEW

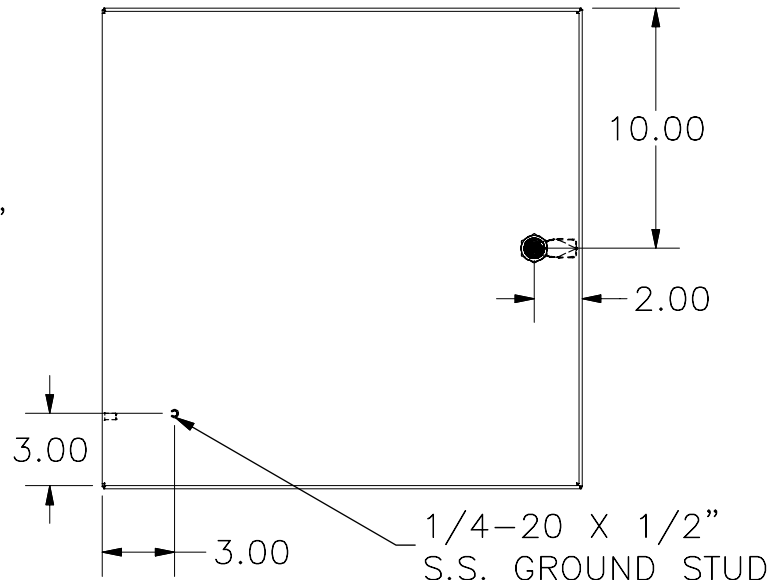

FRONT VIEW

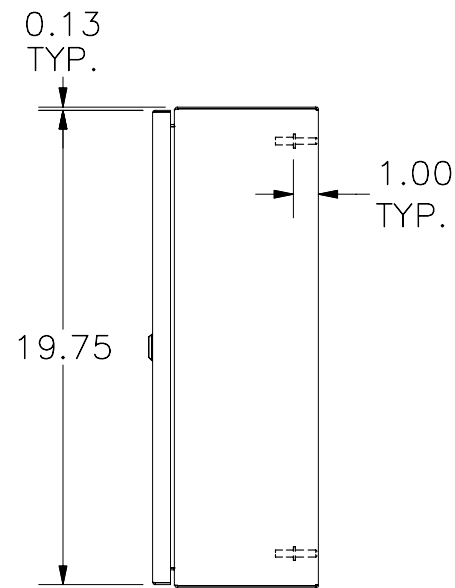

RIGHT SIDE VIEW

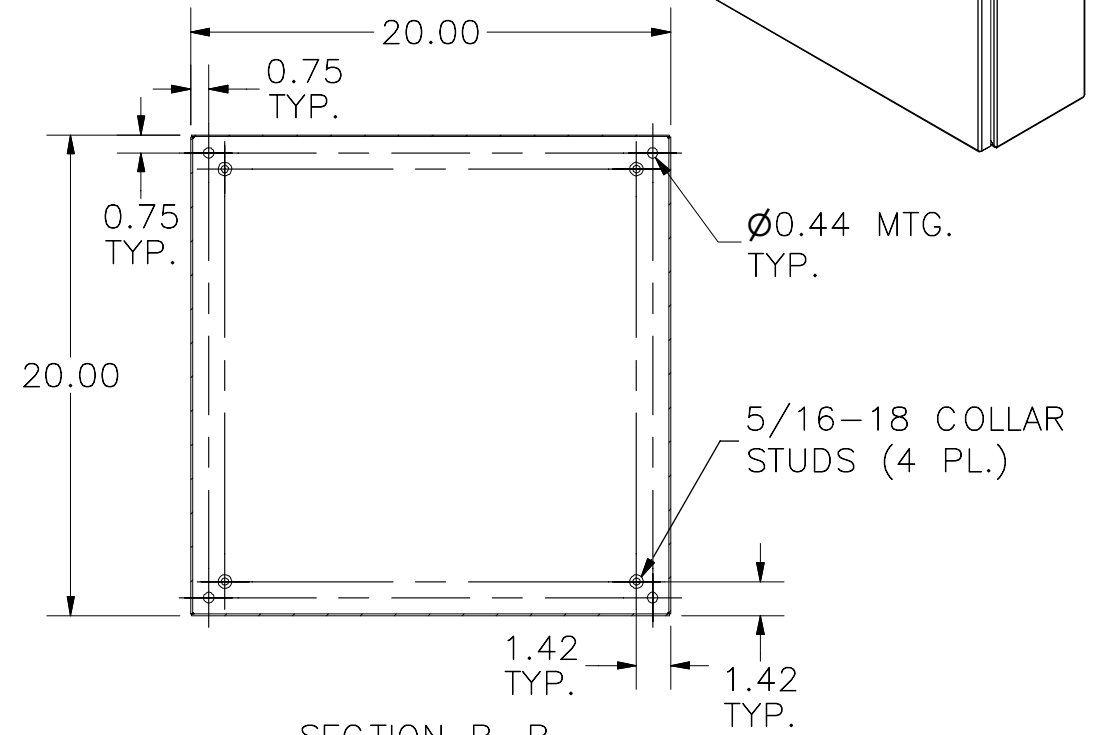

SECTION B-B
(INSIDE BACK OF ENCLOSURE)

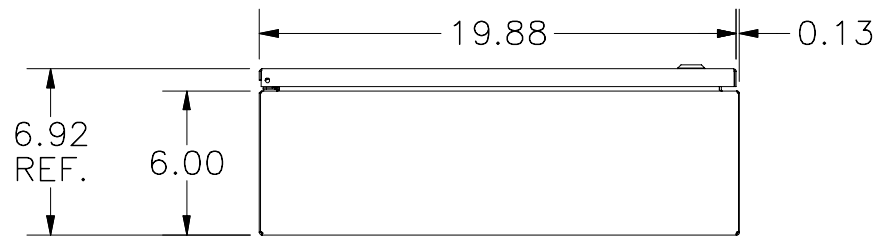
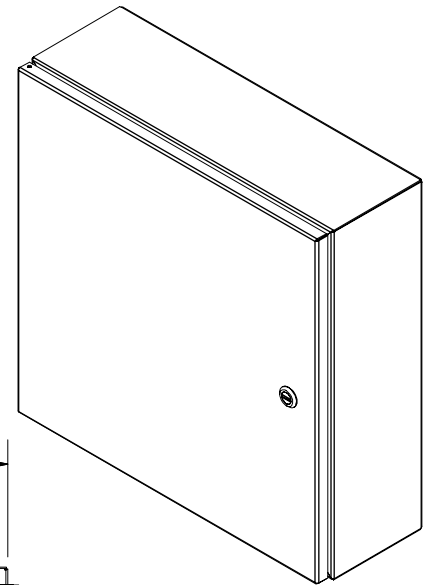

BOTTOM VIEW

PART#: N412202006CLG
(DATA SUBJECT TO CHANGE WITHOUT NOTICE)