

TOP VIEW

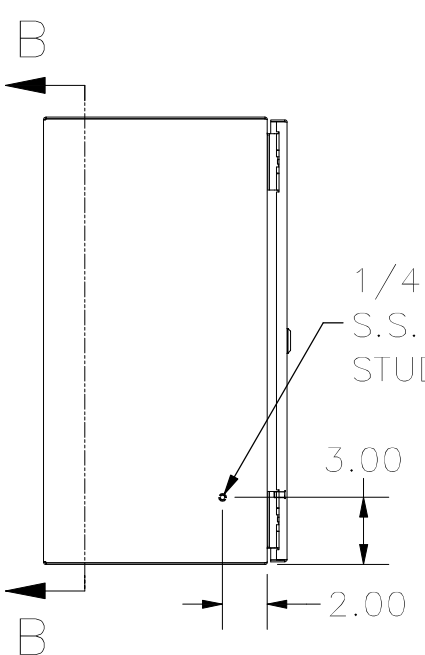

LEFT SIDE VIEW

1/4-20 X 1/2"
S.S. GROUND
STUD

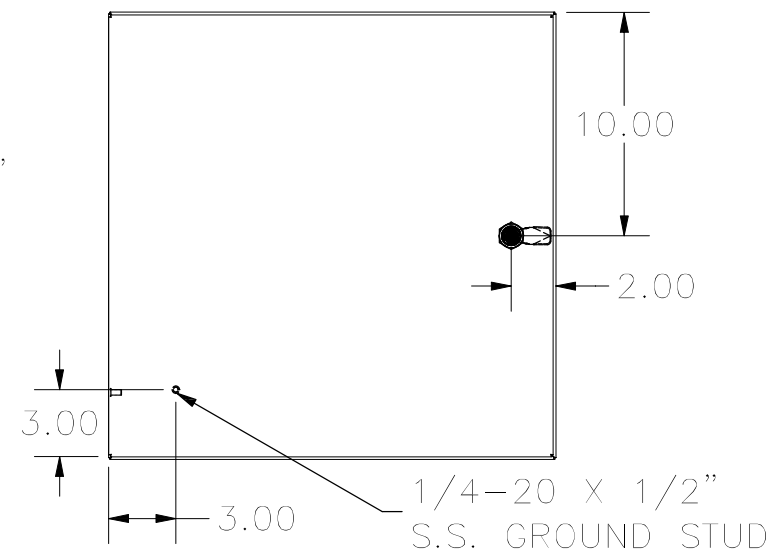

FRONT VIEW

1/4-20 X 1/2"
S.S. GROUND
STUD

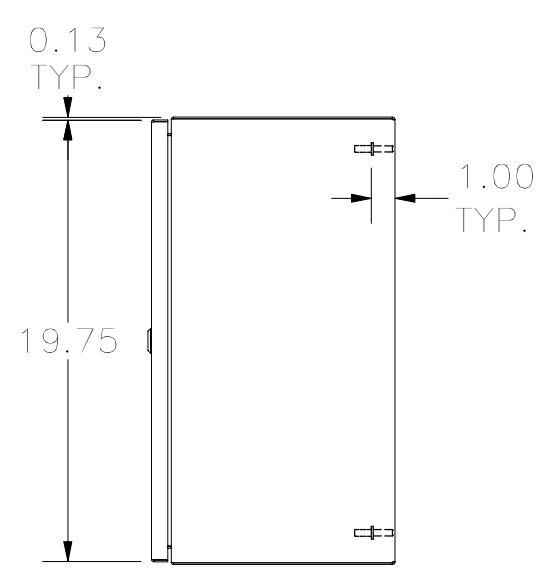

RIGHT SIDE VIEW

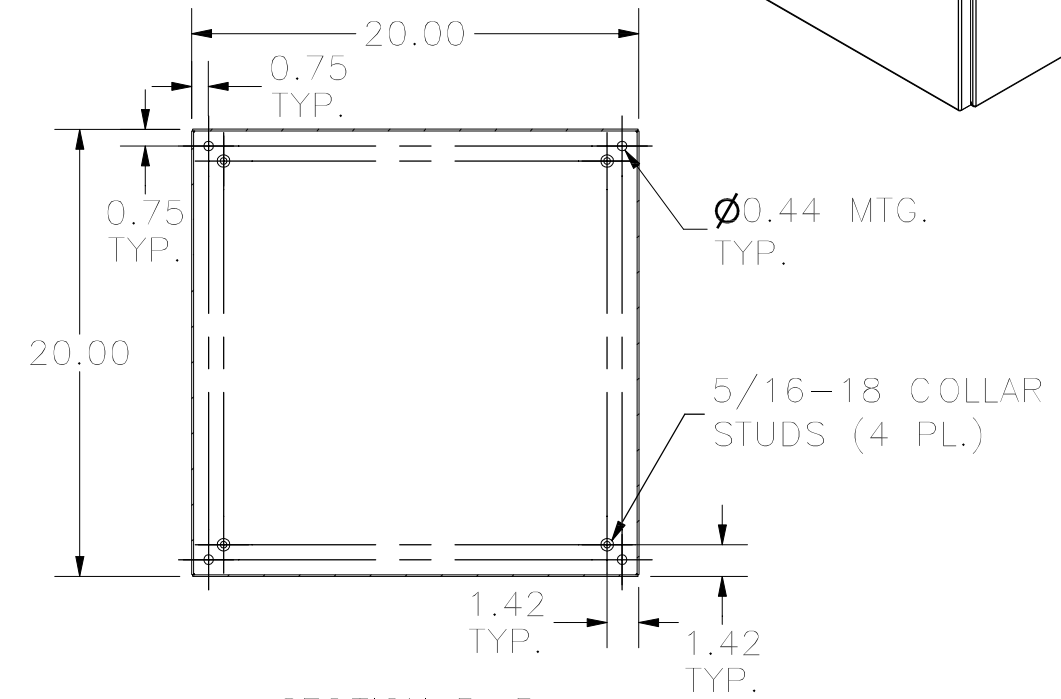

SECTION B-B
(INSIDE BACK OF ENCLOSURE)

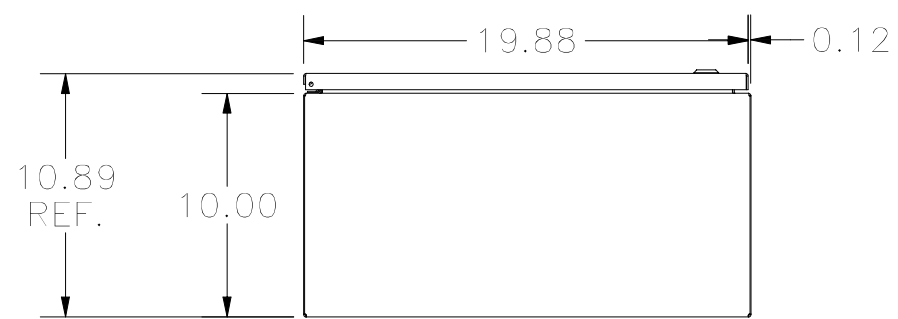

BOTTOM VIEW

PART#: N412202010C
(DATA SUBJECT TO CHANGE WITHOUT NOTICE)

THIS DRAWING IS PROPERTY OF HUBBELL INC. WIEGMANN
ALL INFORMATION IS PROPRIETARY AND NOT TO BE DUPLICATED