

**TOP VIEW**

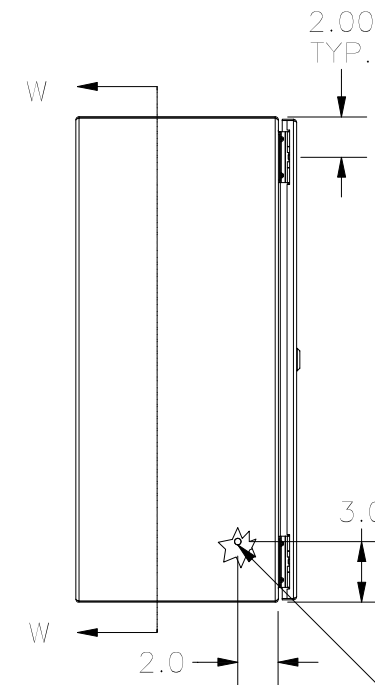

**LEFT SIDE VIEW**

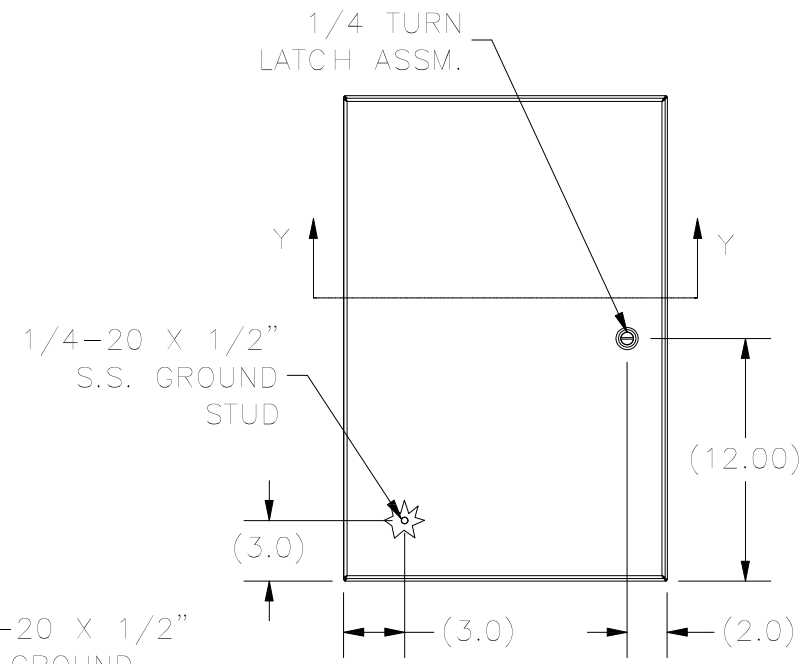

**FRONT VIEW**

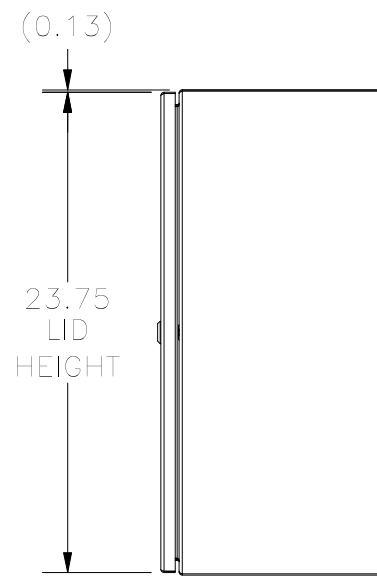

**RIGHT SIDE VIEW**

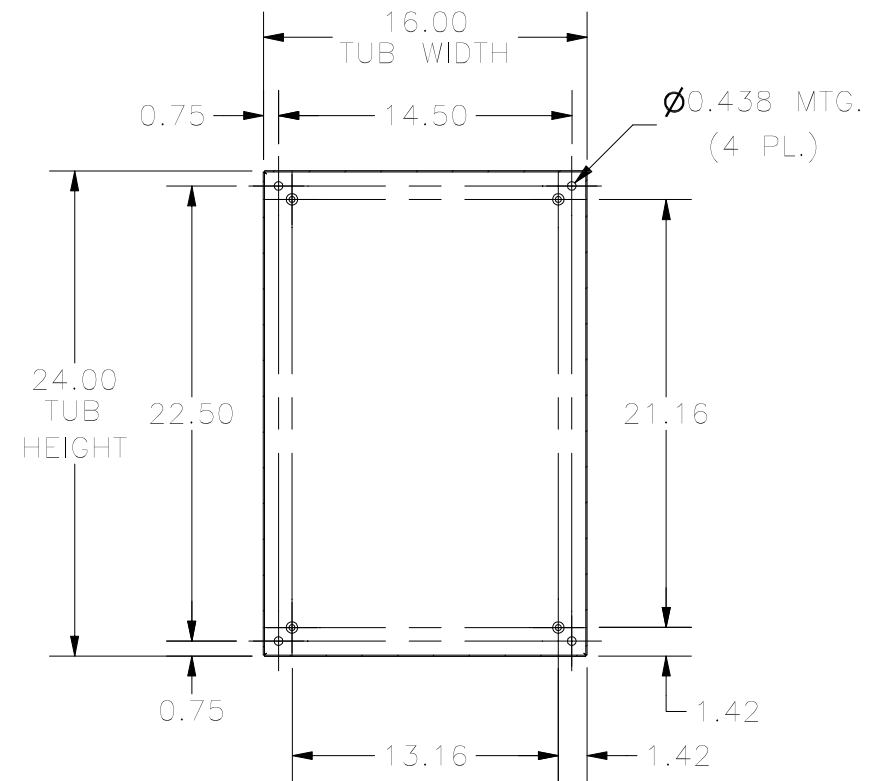

**SECTION W-W  
(INSIDE BACK OF ENCLOSURE)**

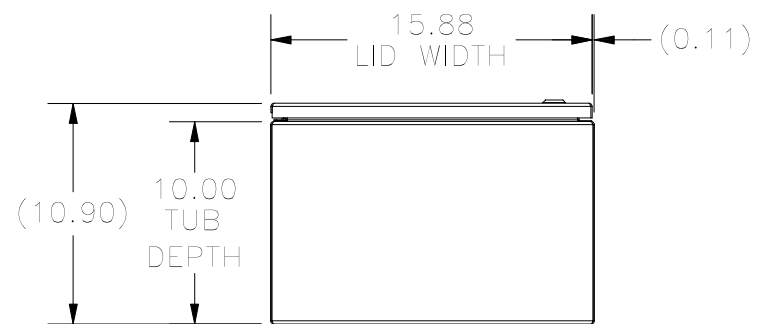

**BOTTOM VIEW**

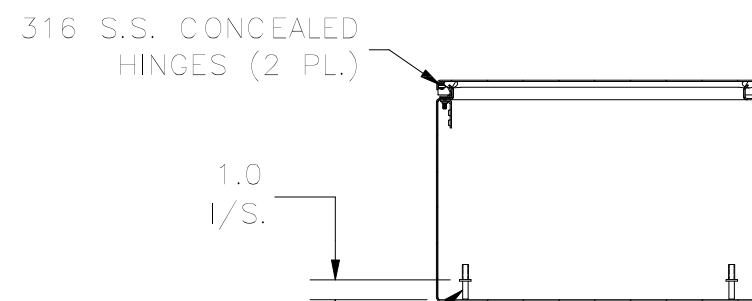

**SECTION Y-Y  
(INSIDE TOP OF ENCLOSURE)**

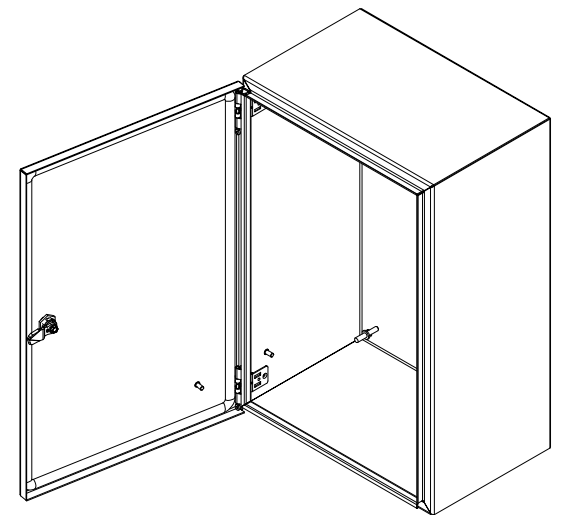
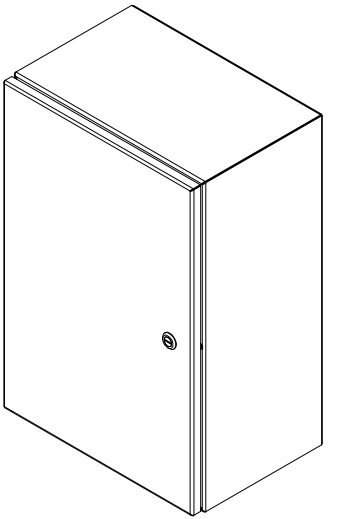

PART #: N412241610SSC  
(DATA SUBJECT TO CHANGE WITHOUT NOTICE.)

THIS DRAWING IS PROPERTY OF HUBBELL INC. WIEGMANN  
ALL INFORMATION IS PROPRIETARY AND NOT TO BE DUPLICATED