

TOP VIEW

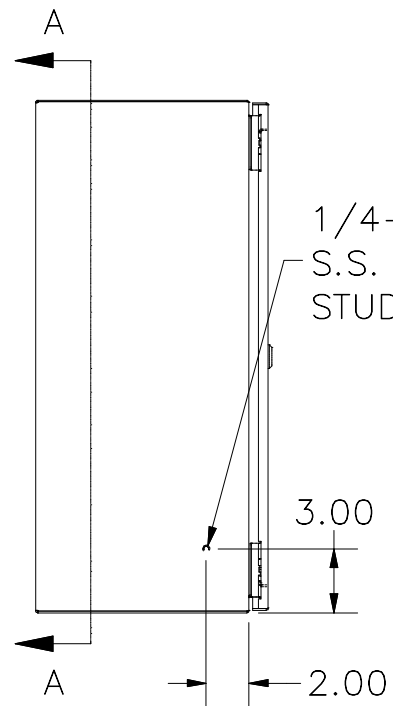

LEFT SIDE VIEW

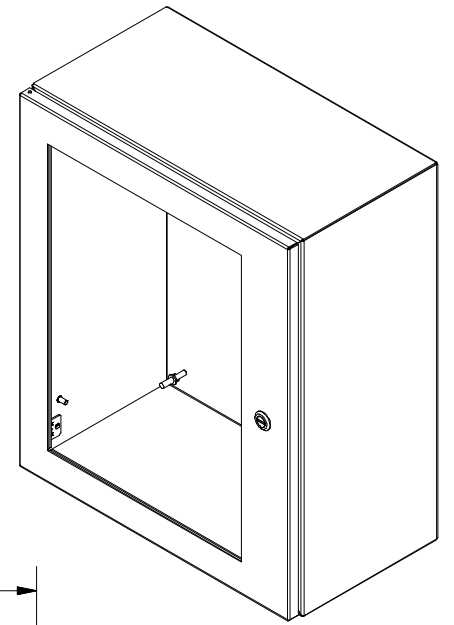
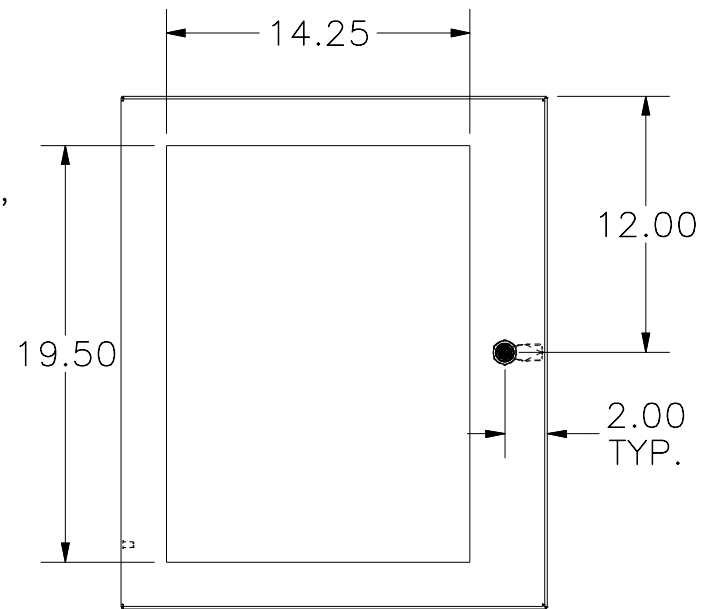

FRONT VIEW

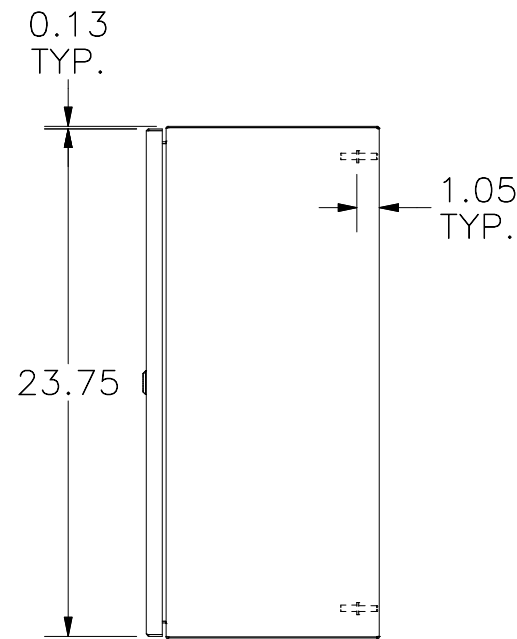

RIGHT SIDE VIEW

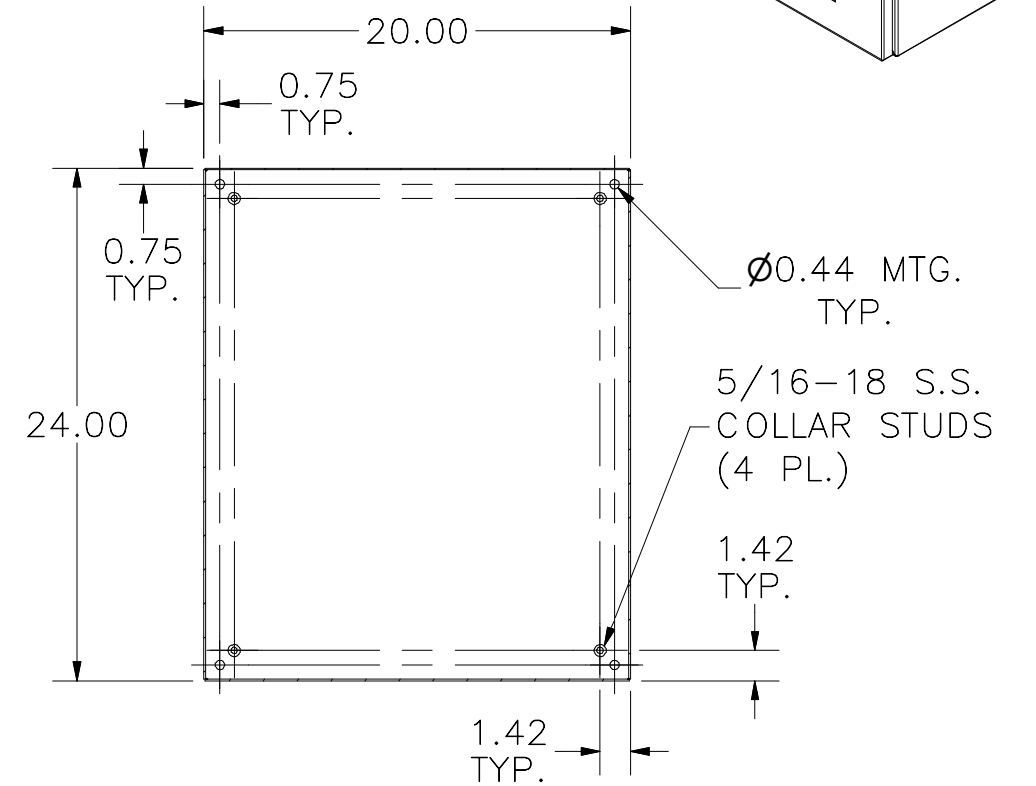

SECTION A-A
(INSIDE BACK OF ENCLOSURE)

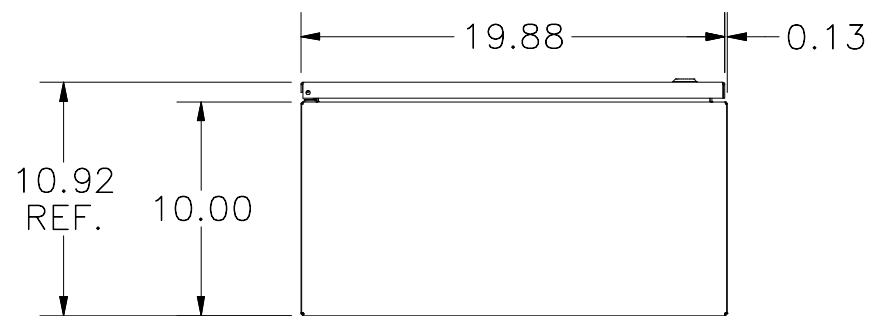

BOTTOM VIEW

PART#: N412242010WCLG
(DATA SUBJECT TO CHANGE WITHOUT NOTICE)