

TOP VIEW

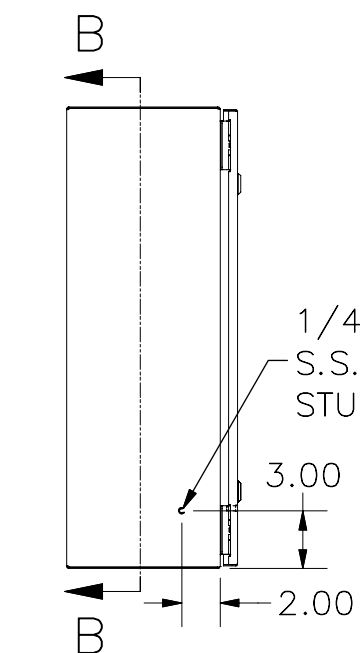

LEFT SIDE VIEW

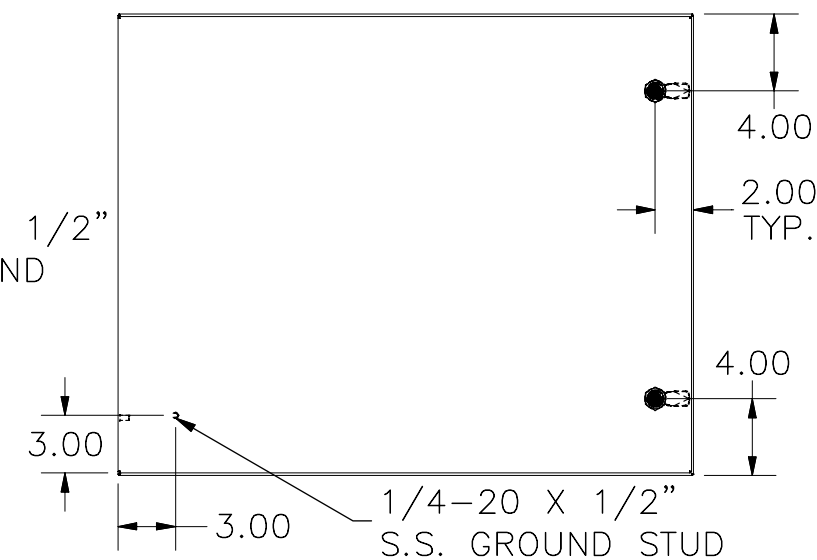

FRONT VIEW

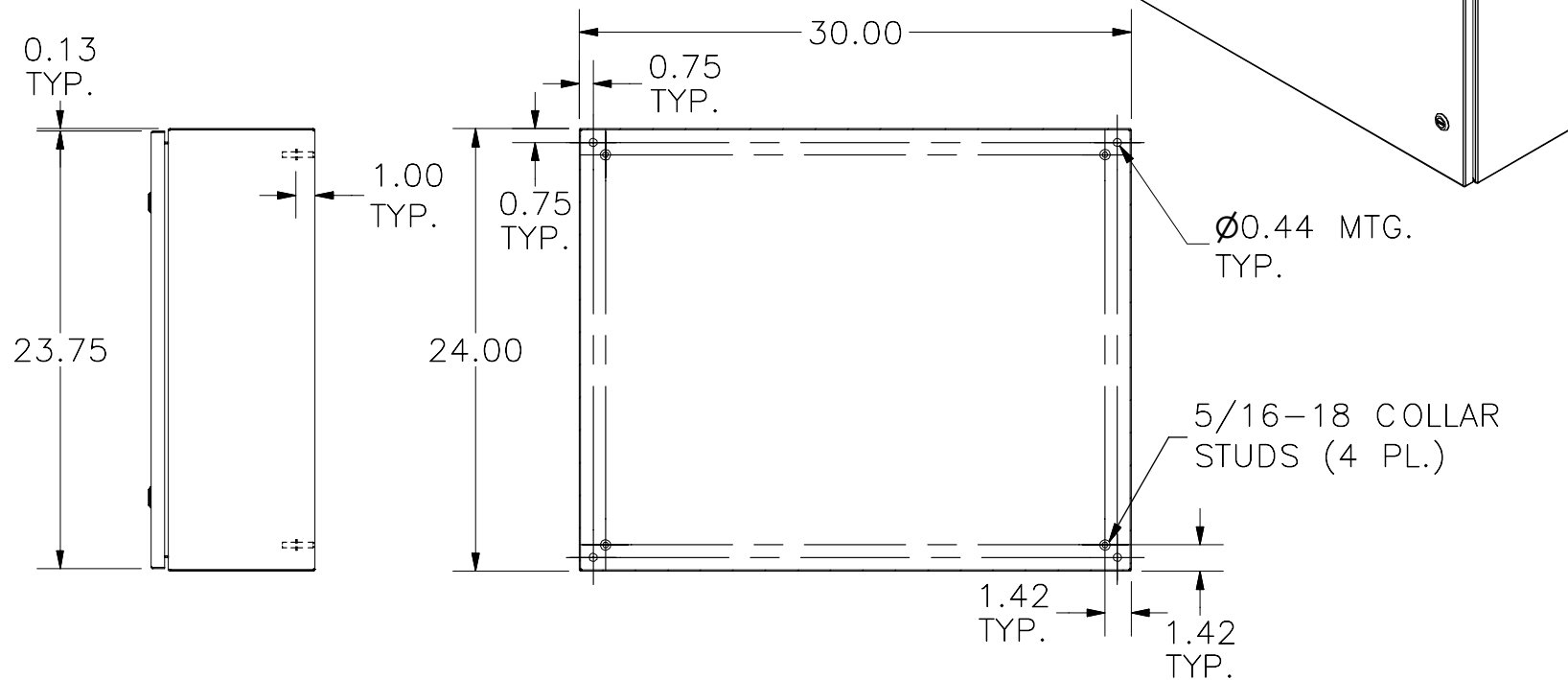

RIGHT SIDE VIEW

SECTION B-B  
(INSIDE BACK OF ENCLOSURE)

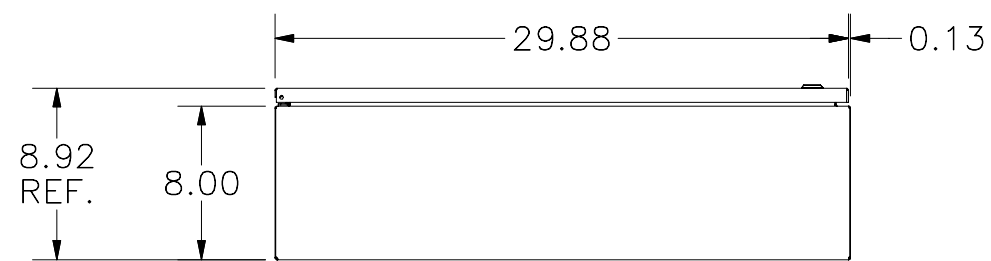

BOTTOM VIEW

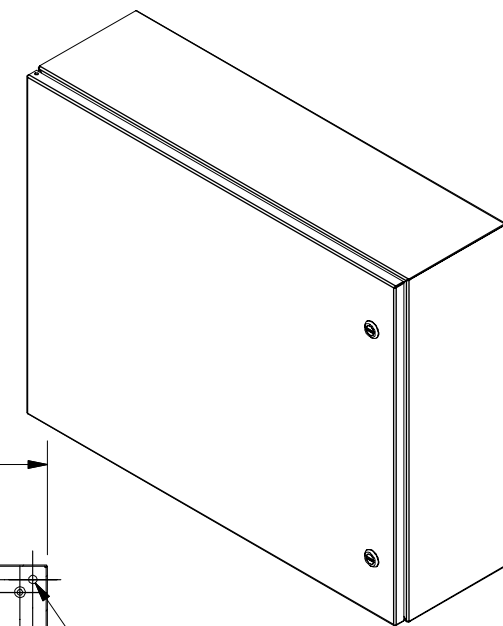

PART#: N412243008CLG  
(DATA SUBJECT TO CHANGE WITHOUT NOTICE)