

**REF. VIEW  
(DOOR OPEN)**

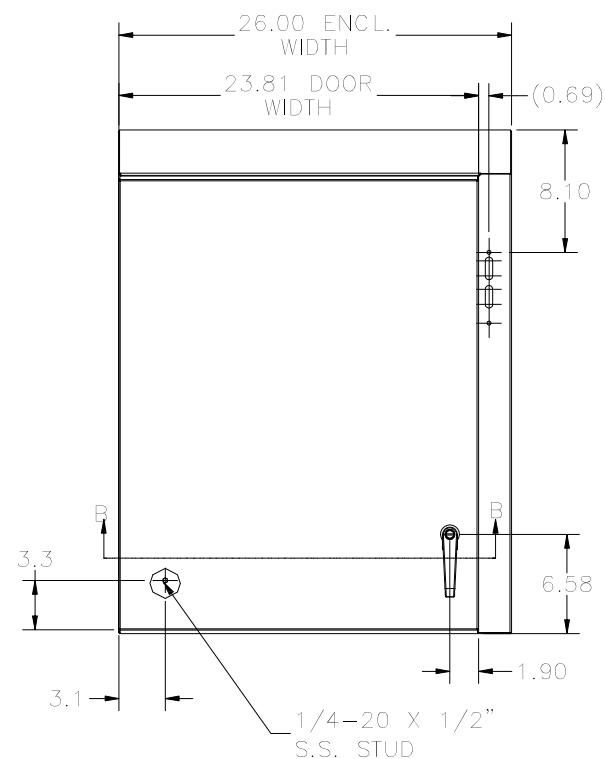

**FRONT VIEW**

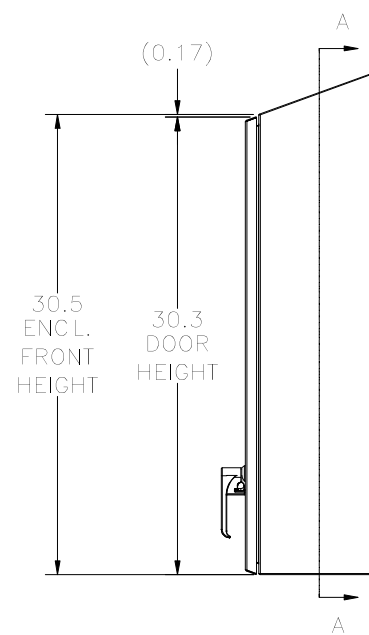

**RIGHT SIDE VIEW**

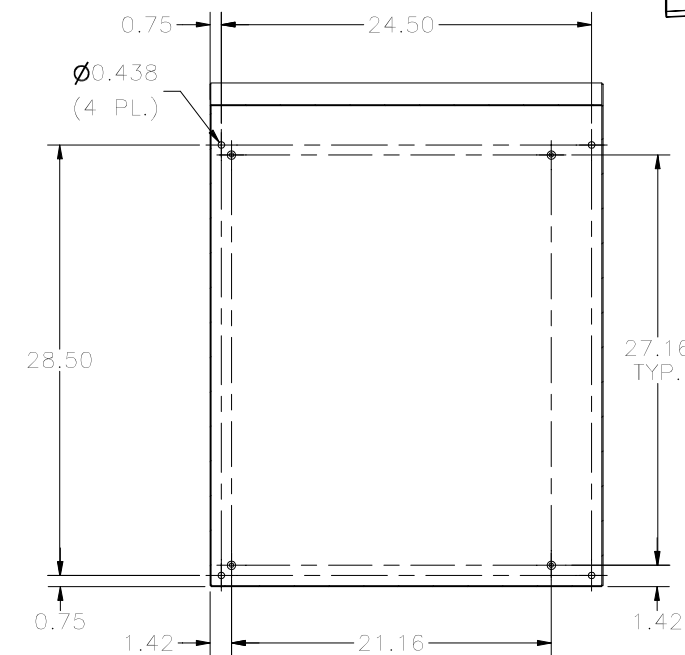

**SECTION A-A VIEW  
(INSIDE BACK OF ENCL.)**

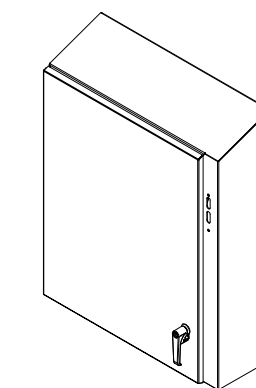

**REF. VIEW  
(DOOR CLOSED)**

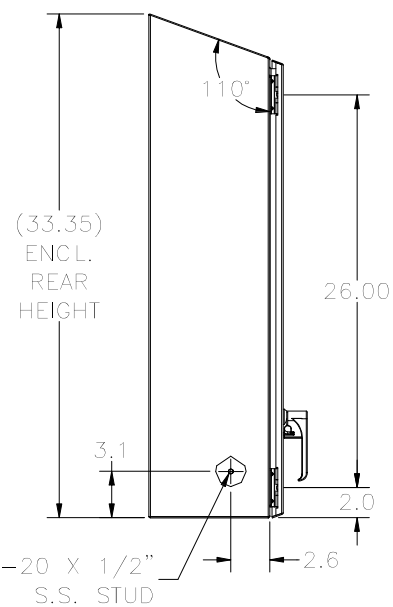

**LEFT SIDE VIEW**

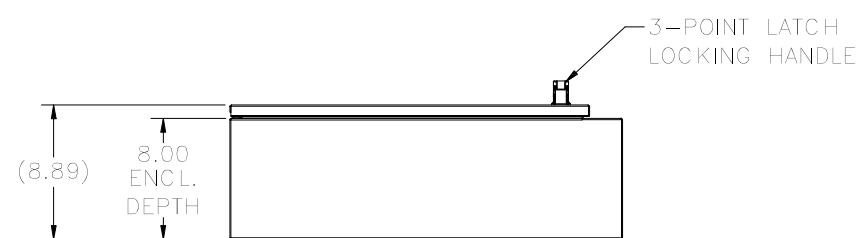

**BOTTOM VIEW**

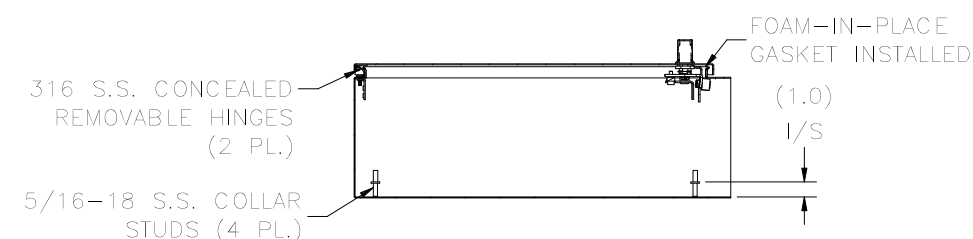

**SECTION B-B VIEW  
(INSIDE TOP OF ENCL.)**

PART#: N412302608C SSSTD  
(DATA SUBJECT TO CHANGE WITHOUT NOTICE)

THIS DRAWING IS PROPERTY OF HUBBELL INC. WIEGMANN  
ALL INFORMATION IS PROPRIETARY AND NOT TO BE DUPLICATED