

TOP VIEW

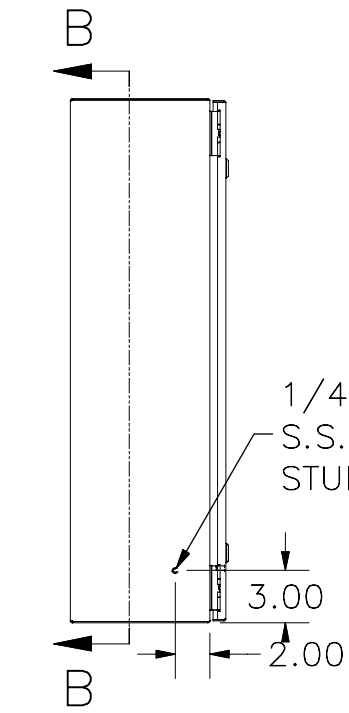

LEFT SIDE VIEW

1/4-20 X 1/2"
S.S. GROUND
STUD

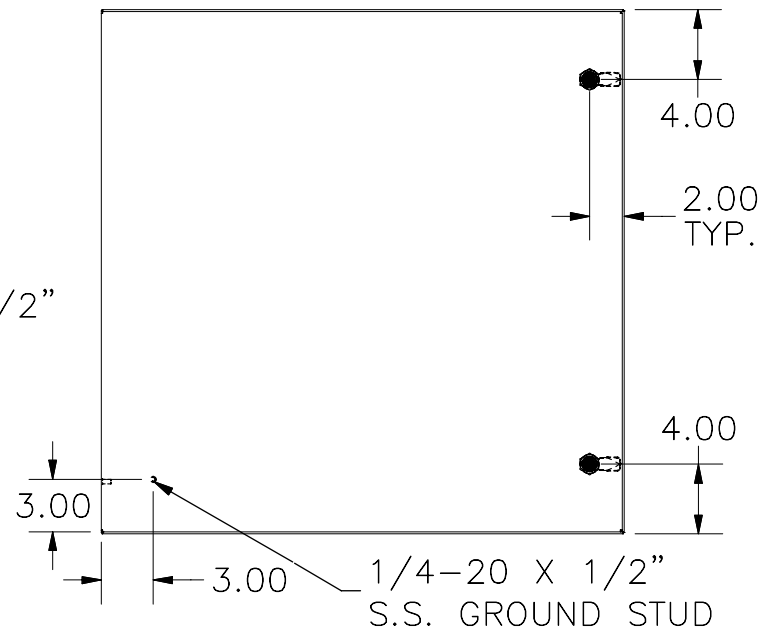

FRONT VIEW

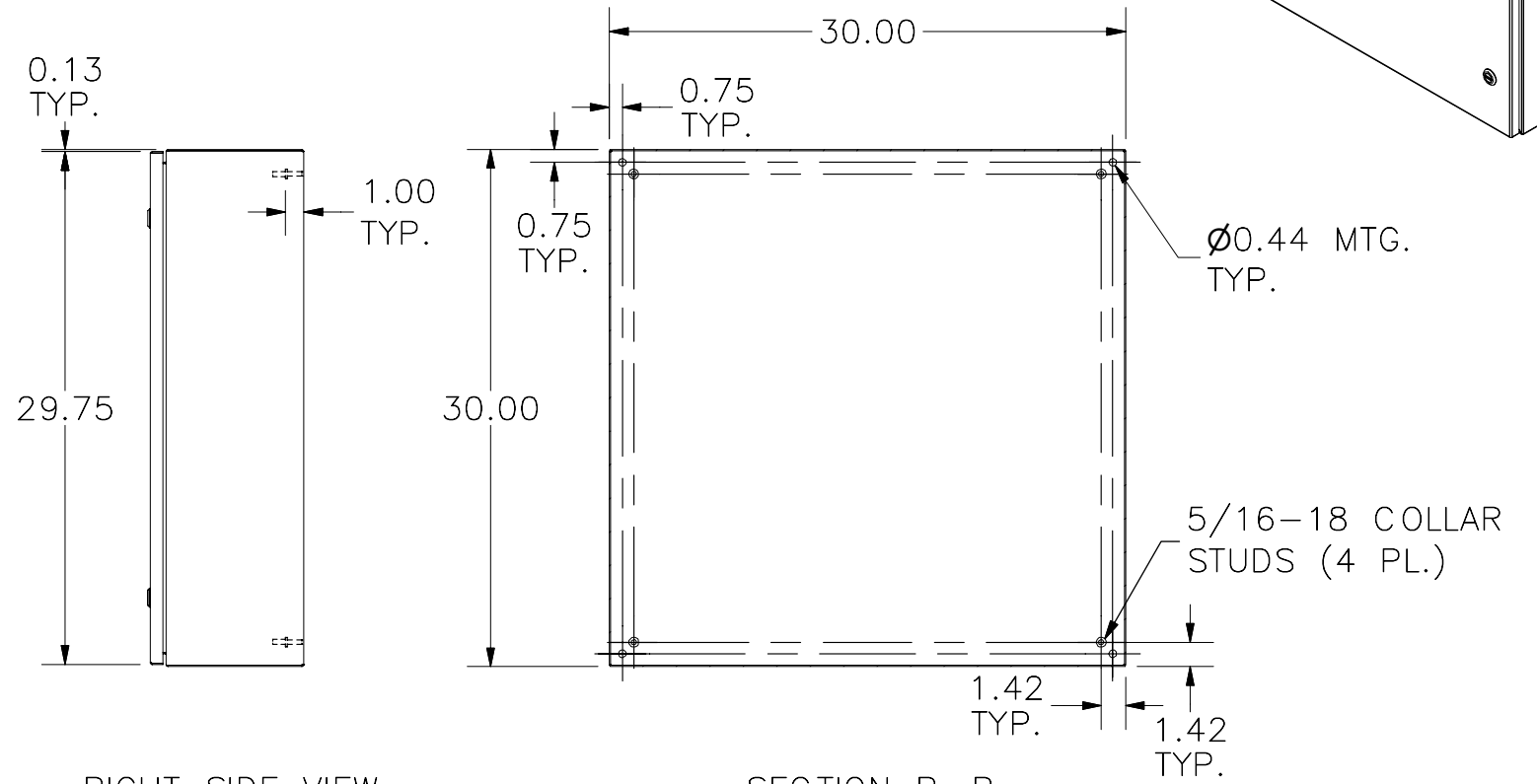

RIGHT SIDE VIEW

SECTION B-B
(INSIDE BACK OF ENCLOSURE)

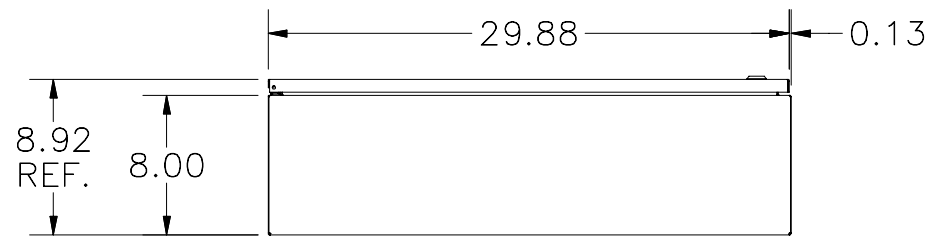

BOTTOM VIEW

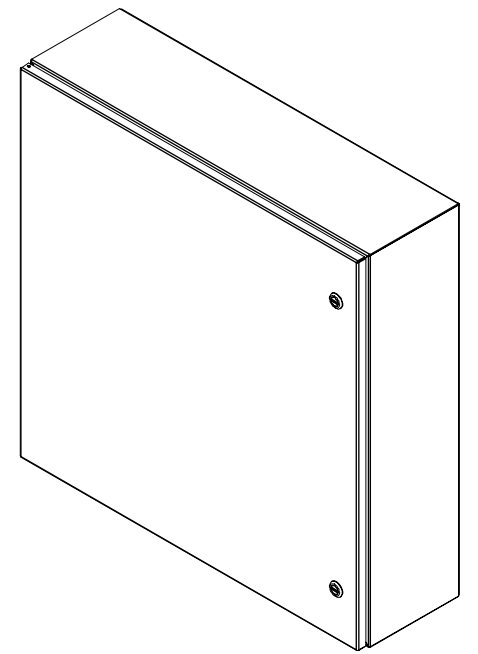

PART#: N412303008CLG
(DATA SUBJECT TO CHANGE WITHOUT NOTICE)