

TOP VIEW

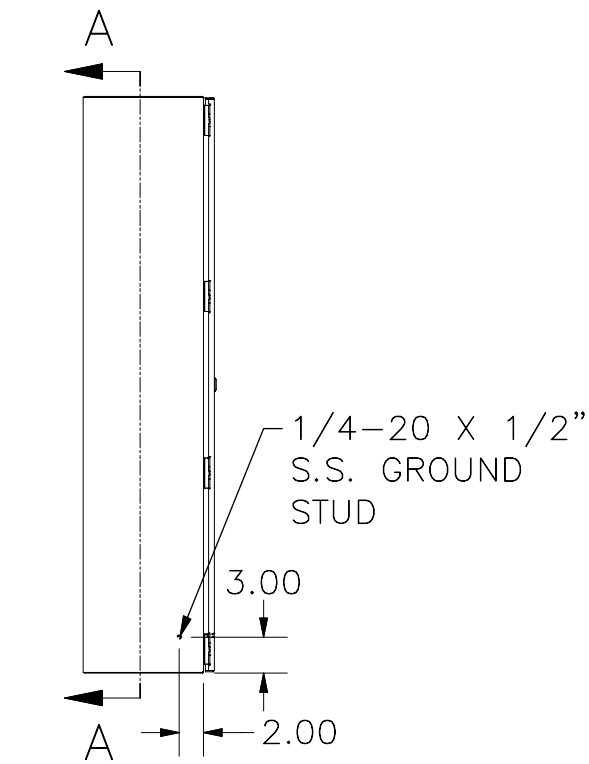

LEFT SIDE VIEW

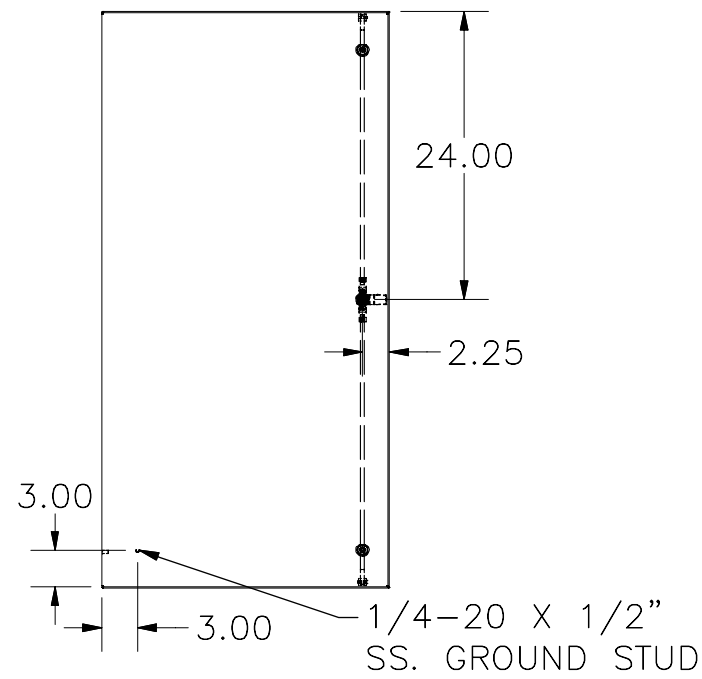

FRONT VIEW

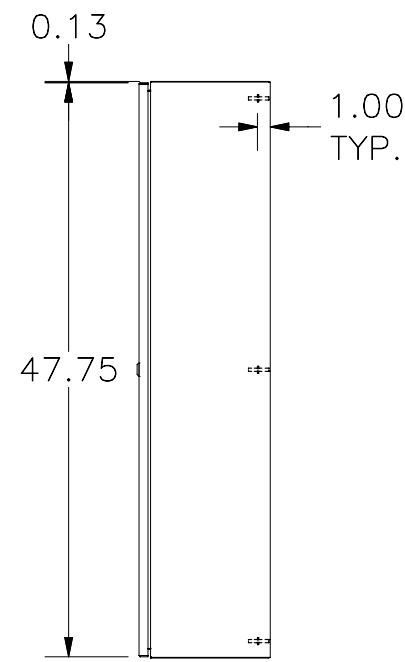

RIGHT SIDE VIEW

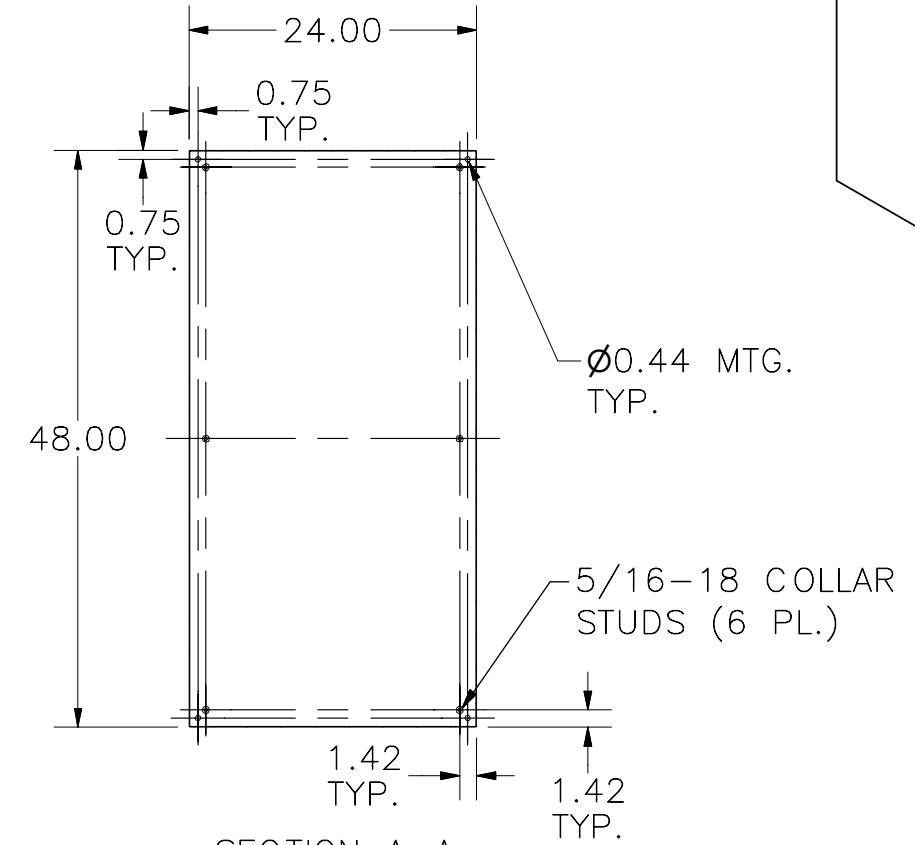

SECTION A-A  
(INSIDE BACK OF ENCLOSURE)

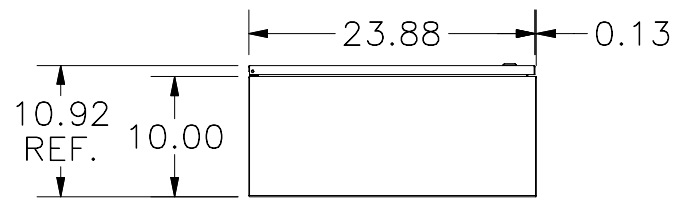
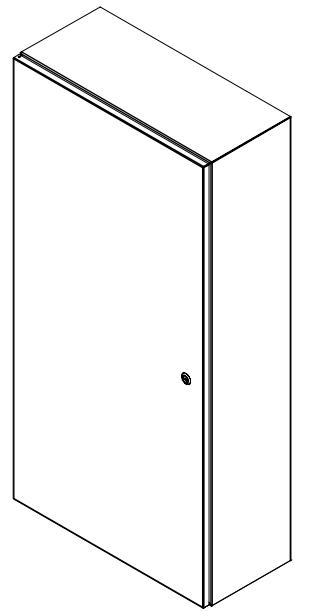

BOTTOM VIEW

PART#: N412482410CLG  
(DATA SUBJECT TO CHANGE WITHOUT NOTICE)