

TOP VIEW

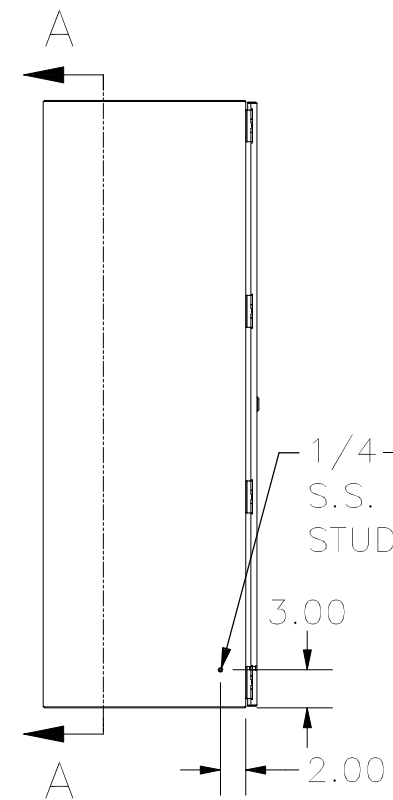

LEFT SIDE VIEW

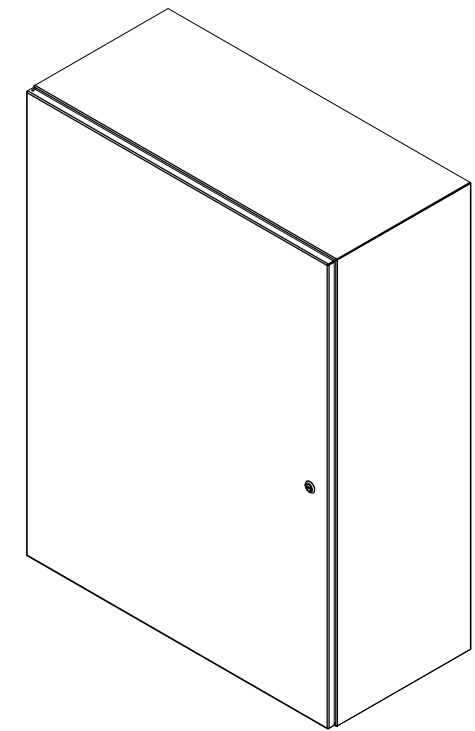
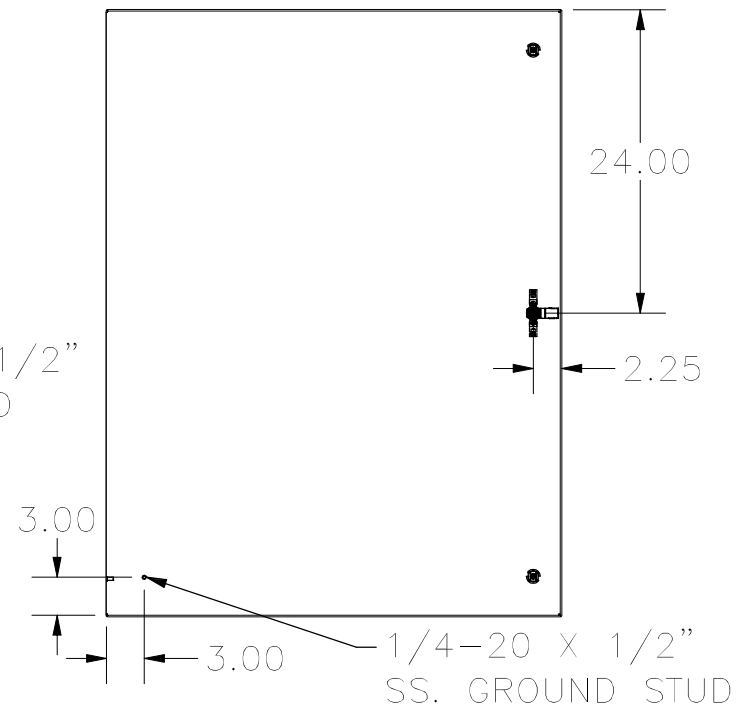

FRONT VIEW

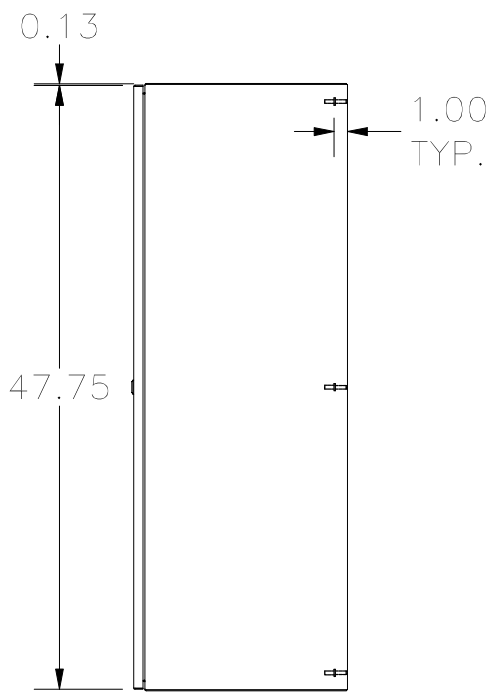

RIGHT SIDE VIEW

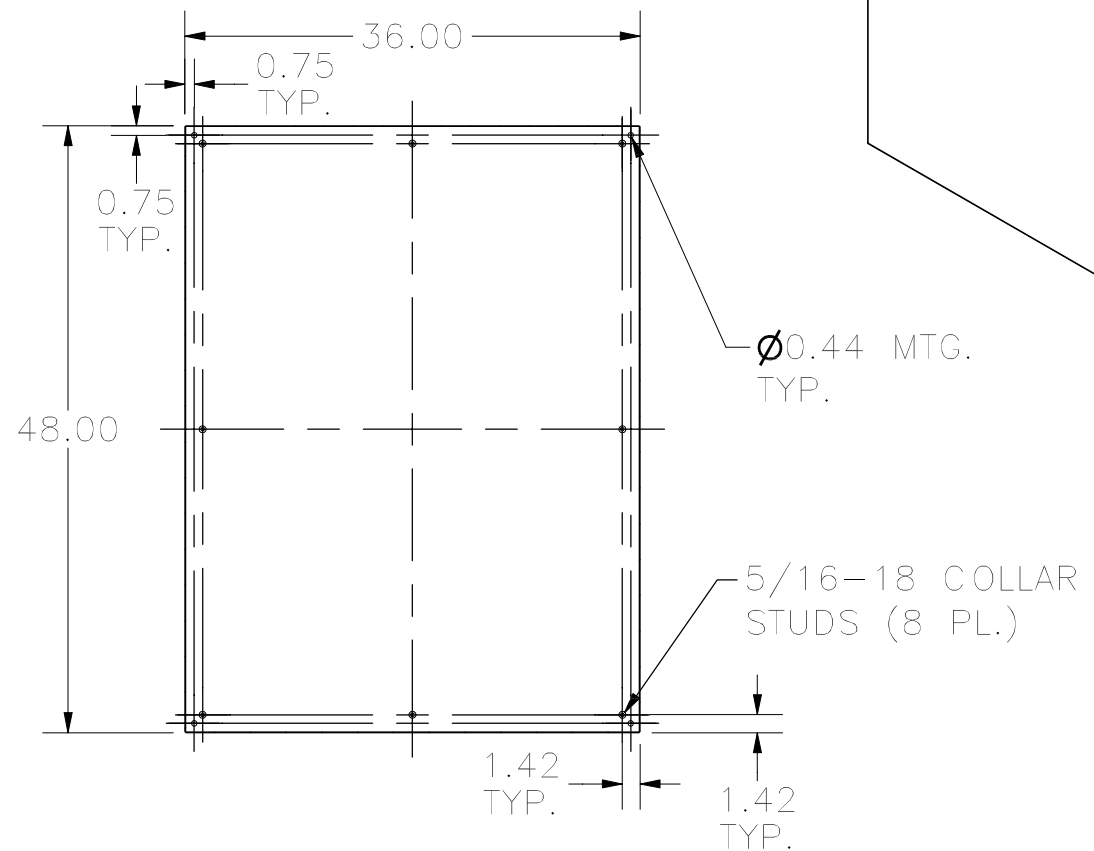

SECTION A-A  
(INSIDE BACK OF ENCLOSURE)

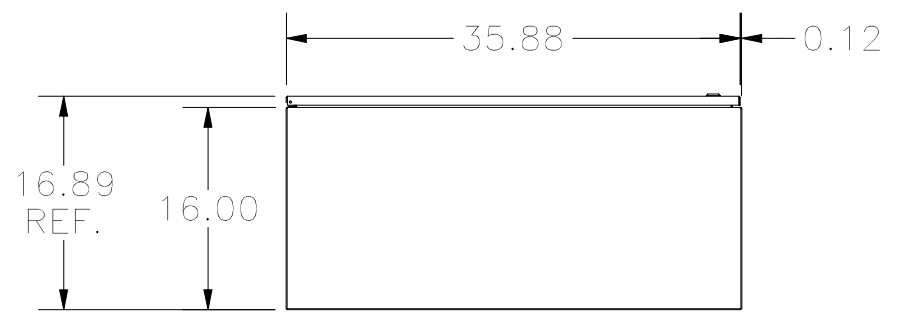

BOTTOM VIEW

PART#: N412483616C  
(DATA SUBJECT TO CHANGE WITHOUT NOTICE)

THIS DRAWING IS PROPERTY OF HUBBELL INC. WIEGMANN  
ALL INFORMATION IS PROPRIETARY AND NOT TO BE DUPLICATED