

TOP VIEW

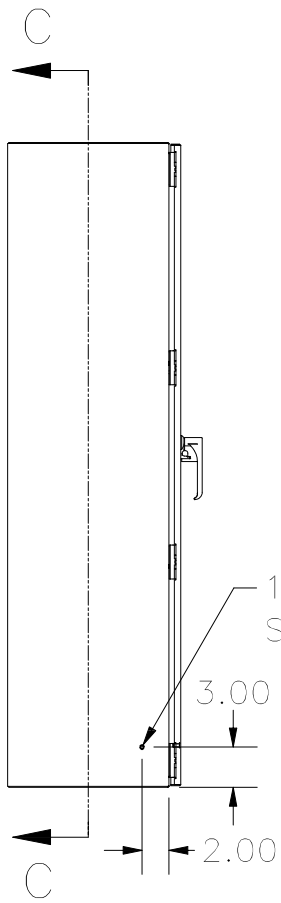

LEFT SIDE VIEW

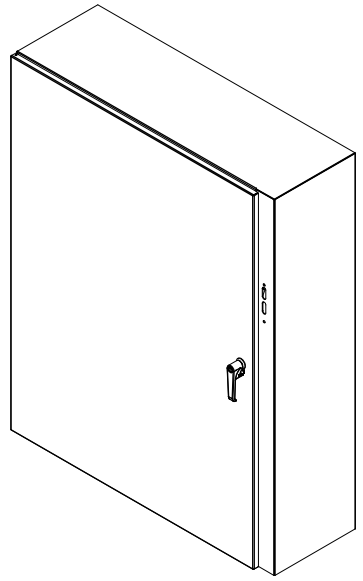
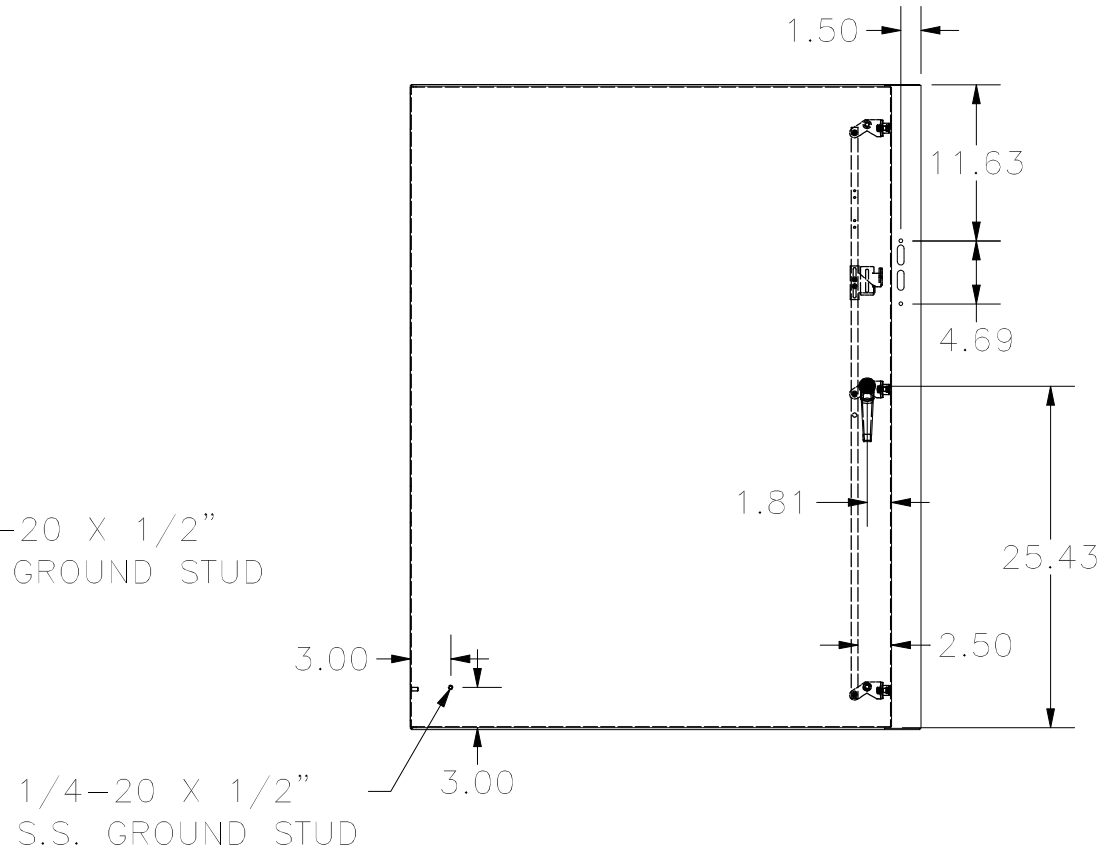

FRONT VIEW

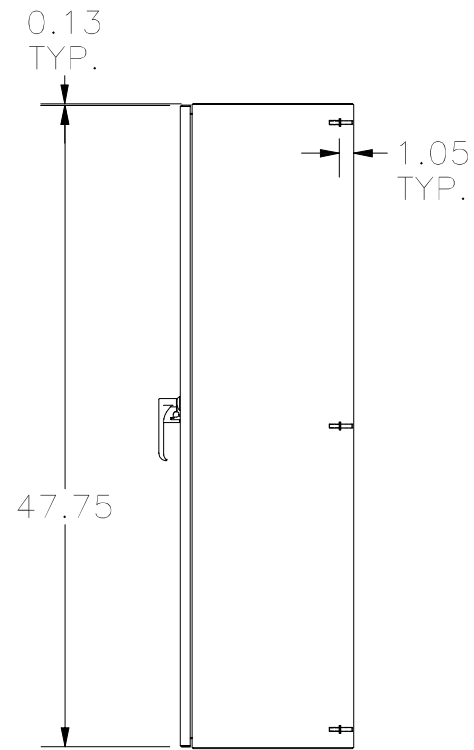

RIGHT SIDE VIEW

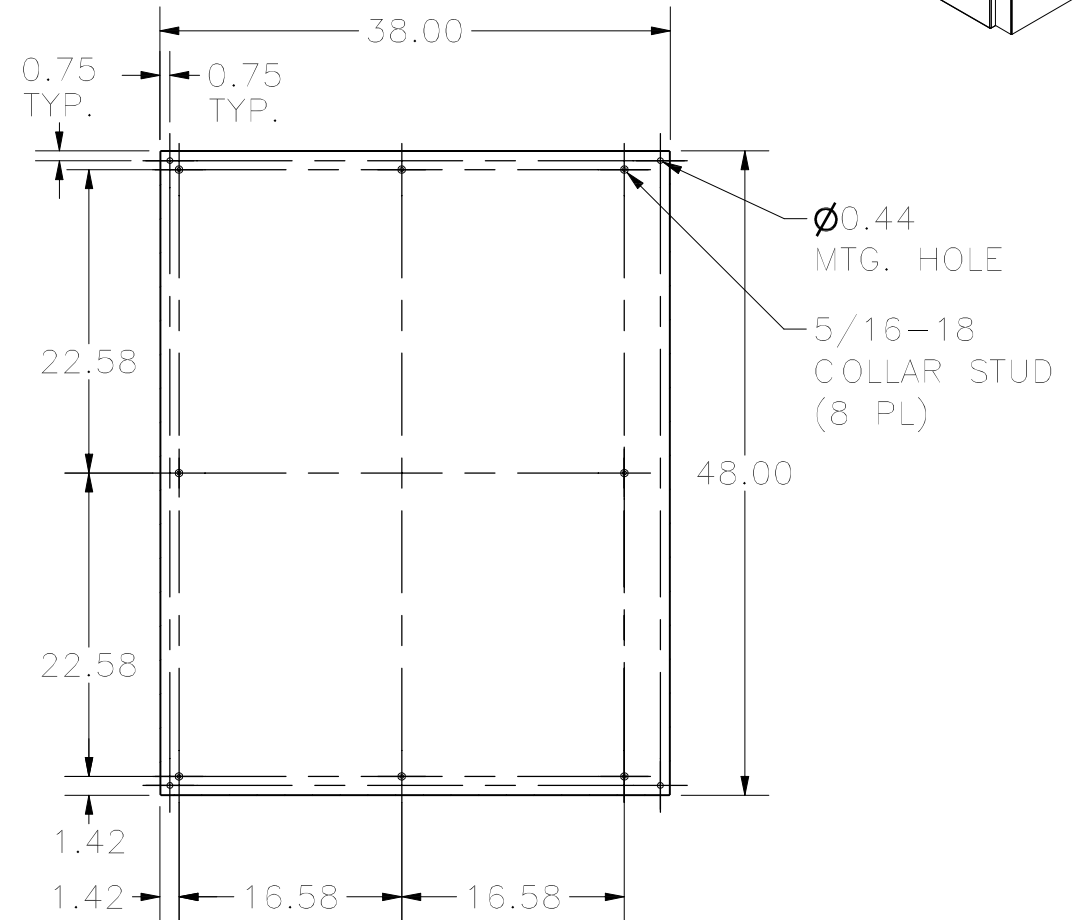

SECTION C-C
(INSIDE BACK OF ENCLOSURE)

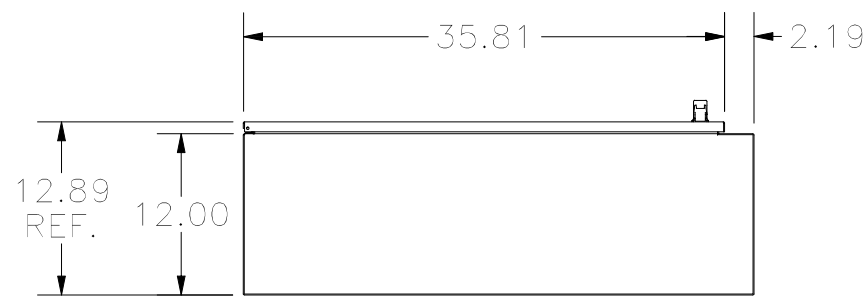

BOTTOM VIEW

PART #: N412483812CD
 (DATA SUBJECT TO CHANGE WITHOUT NOTICE.)
 THIS DRAWING IS PROPERTY OF HUBBELL INC. WIEGMANN
 ALL INFORMATION IS PROPRIETARY AND NOT TO BE DUPLICATED