

SECTION C-C (INSIDE LEFT OF ENCL.)

SECTION B-B (INSIDE BACK OF ENCL.)

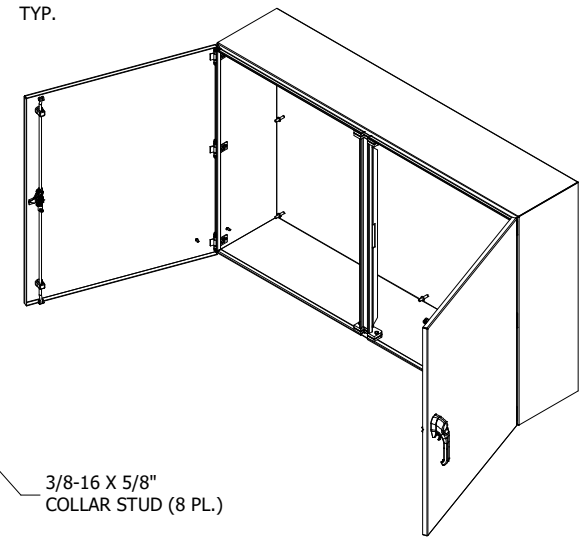
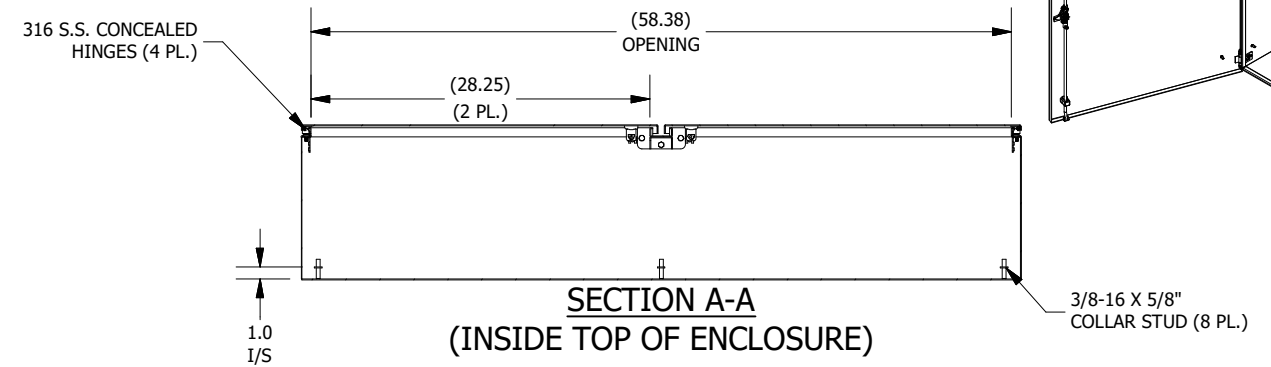
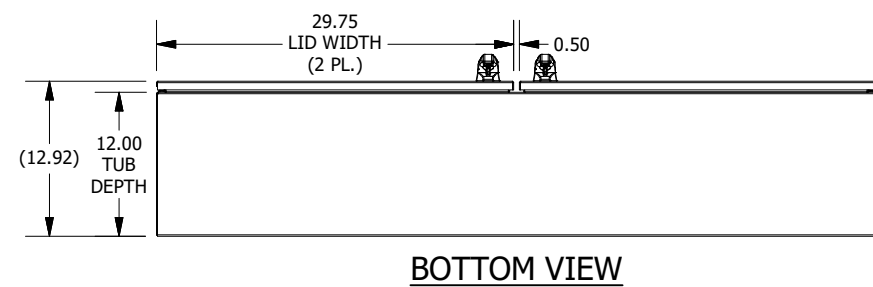

PART #:N412D366012SSC
 (DATA SUBJECT TO CHANGE WITHOUT NOTICE)
 THIS DRAWING IS THE PROPERTY OF HUBBELL INC. WIEGMANN
 ALL INFORMATION IS PROPRIETARY AND NOT TO BE DUPLICATED