

LEFT SIDE

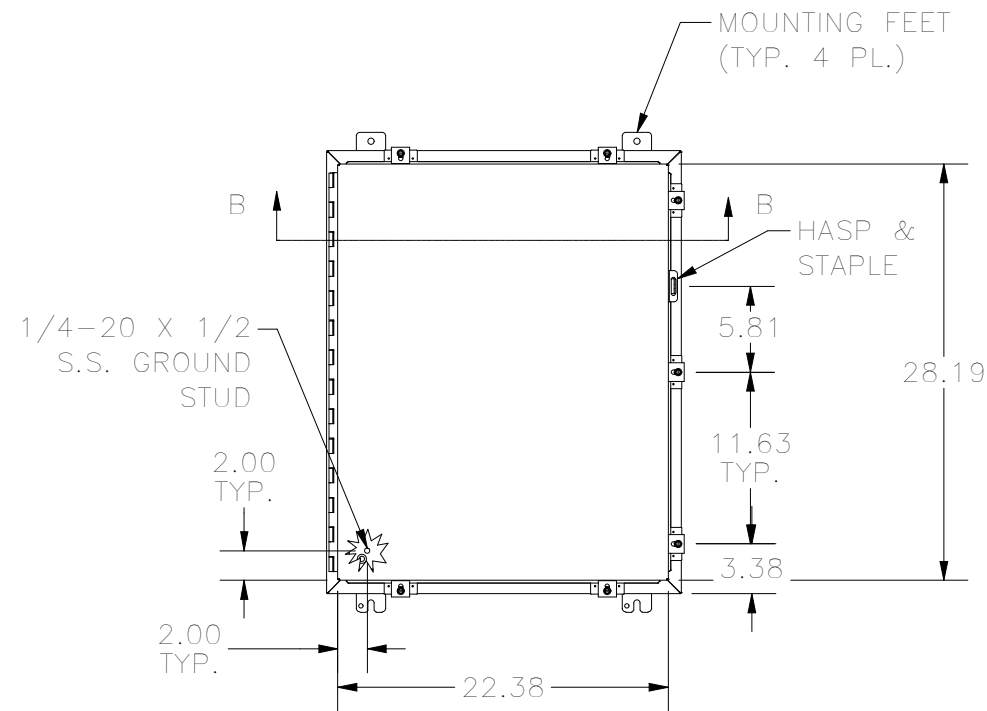

FRONT VIEW

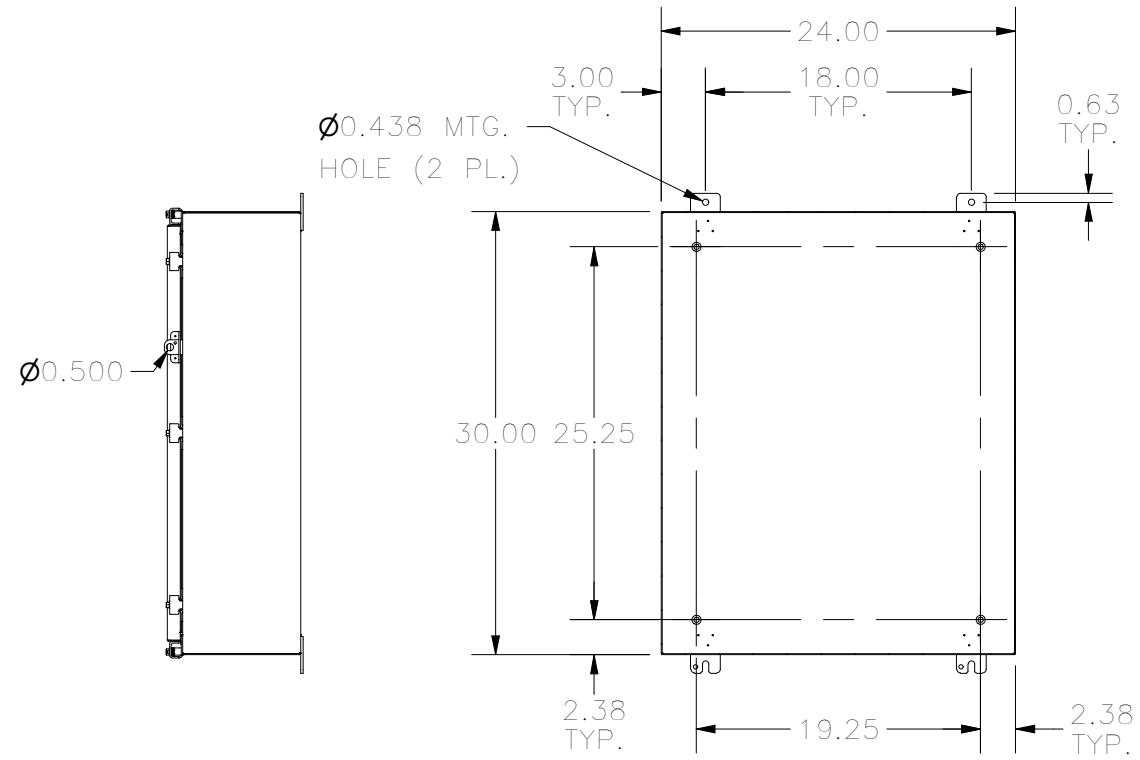

RIGHT VIEW

SECTION A-A

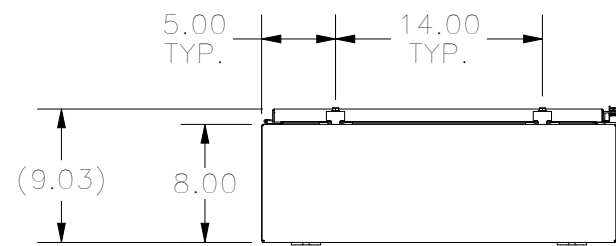
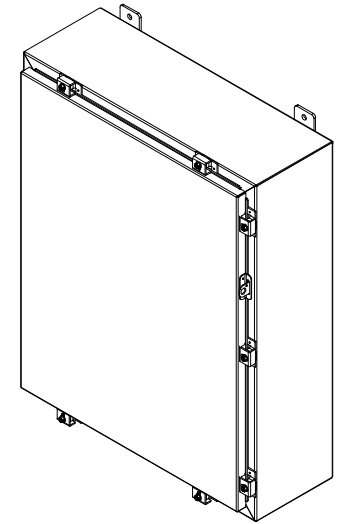

BOTTOM VIEW

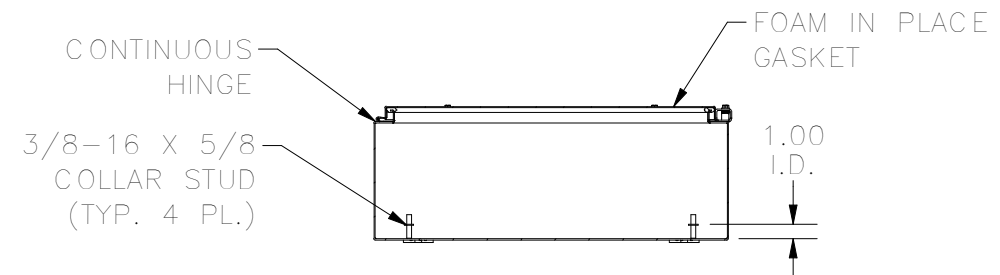

SECTION B-B

PART #:N4302408
 (DATA SUBJECT TO CHANGE WITHOUT NOTICE)
 THIS DRAWING IS THE PROPERTY OF HUBBELL INC. WIEGMANN
 ALL INFORMATION IS PROPRIETARY AND NOT TO BE DUPLICATED