

**TOP VIEW**

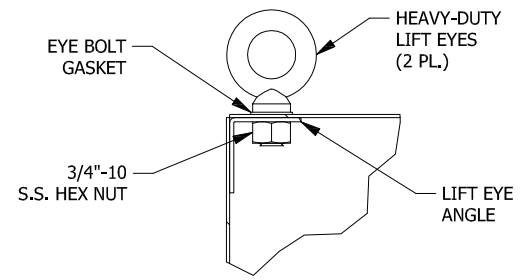

**DETAIL AD  
(LIFT EYE ASSEMBLY VIEW)**

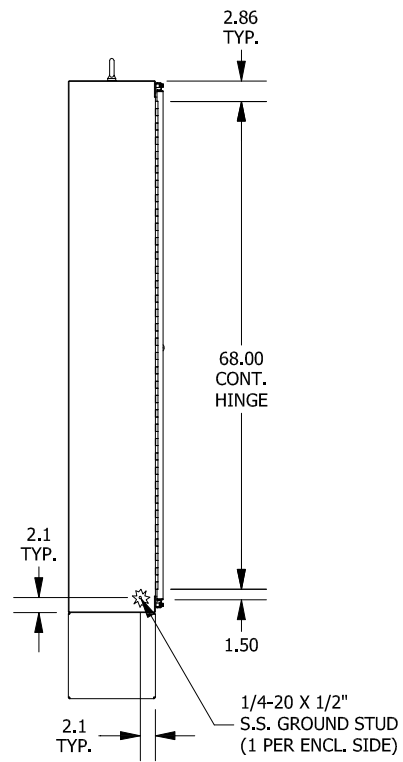
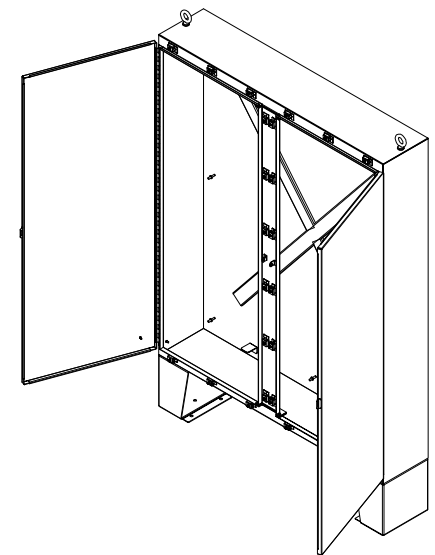

**LEFT SIDE VIEW**

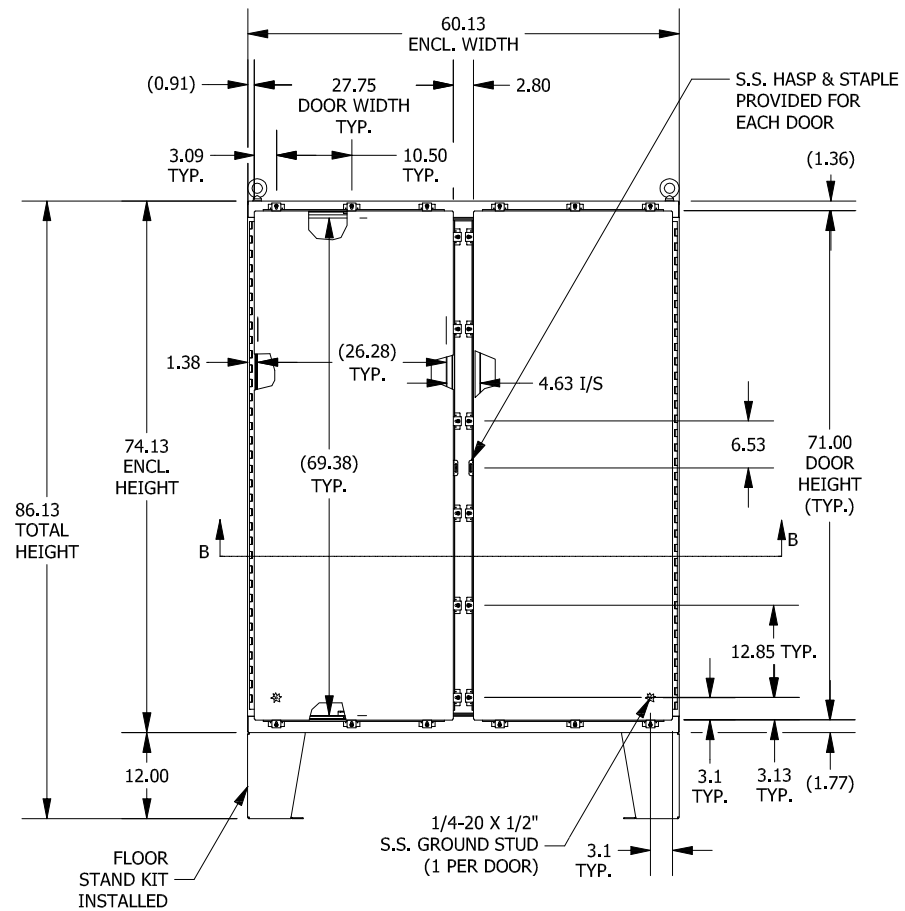

**FRONT VIEW**

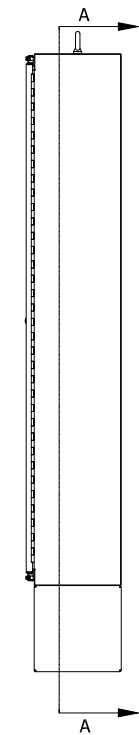

**RIGHT SIDE VIEW**

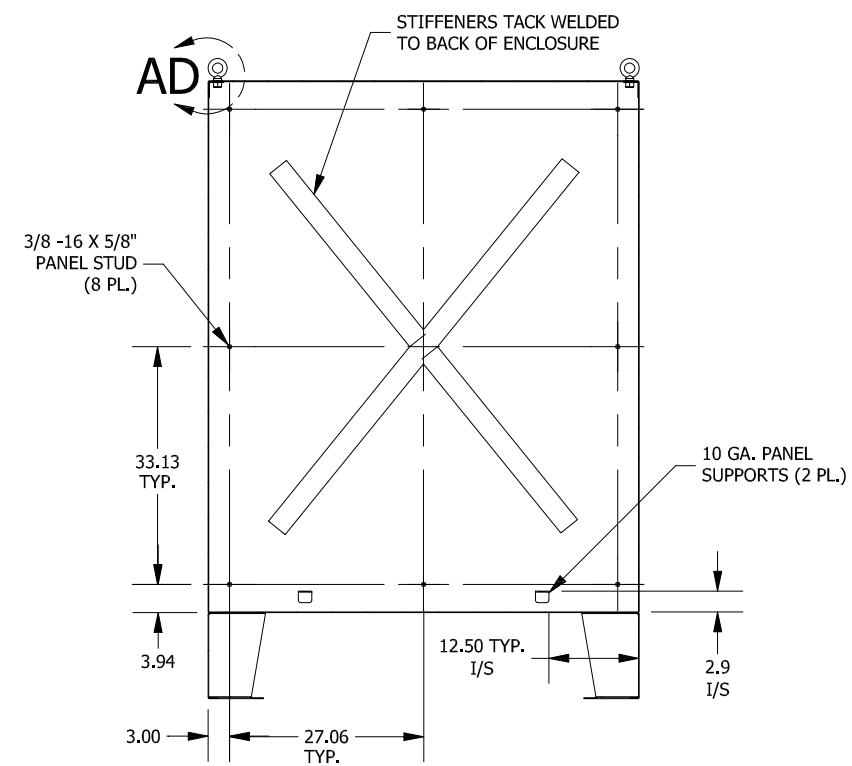

**SECTION A-A  
(INSIDE BACK VIEW OF ENCLOSURE)**

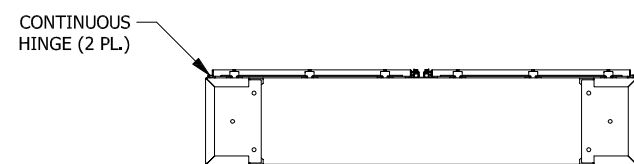
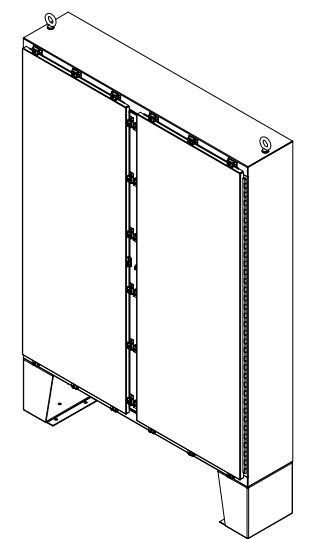

**BOTTOM VIEW**

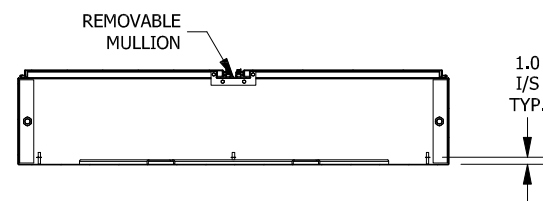

**SECTION B-B  
(INSIDE VIEW OF TOP)**

PART#: N4D746012  
(DATA SUBJECT TO CHANGE WITHOUT NOTICE)

THIS DRAWING IS PROPERTY OF HUBBELL INC. WIEGMANN  
ALL INFORMATION IS PROPRIETARY AND NOT TO BE DUPLICATED