

FRONT VIEW

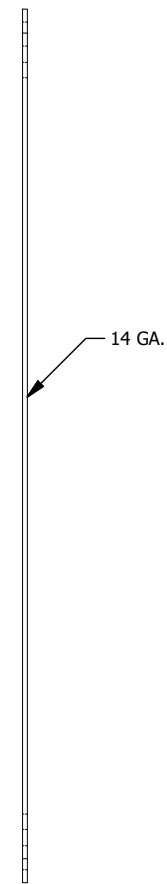

SIDE VIEW

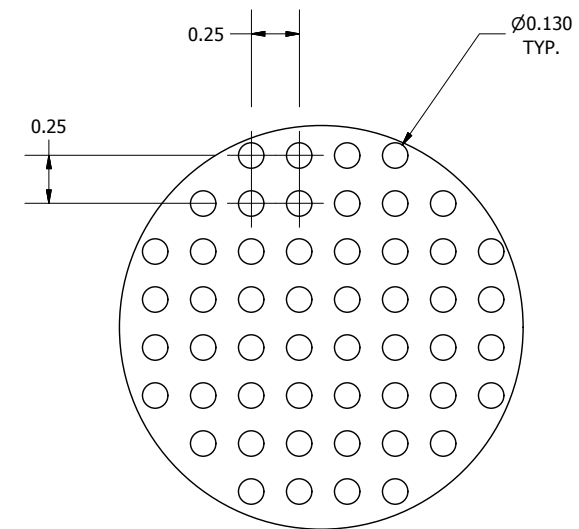
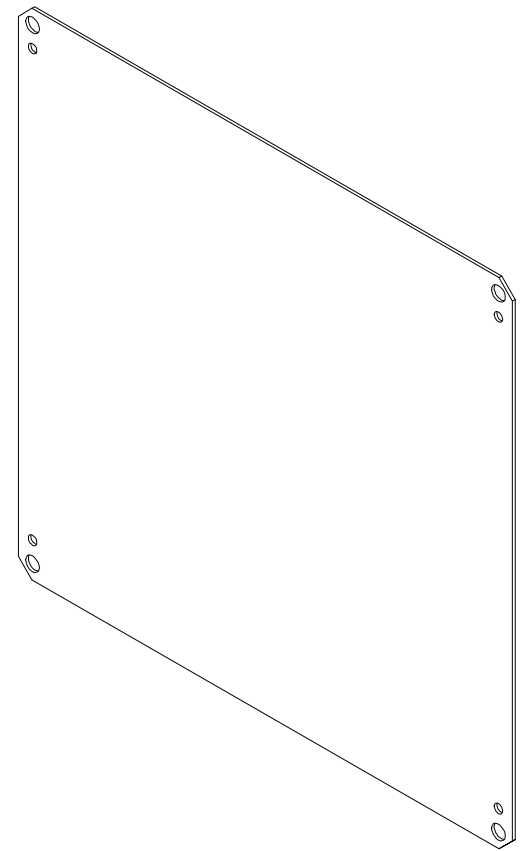

**DETAIL-A
(PERFORATED DETAIL)**

PART#: NP2020CPP
(DATA SUBJECT TO CHANGE WITHOUT NOTICE)

THIS DRAWING IS PROPERTY OF HUBBELL INC. WIEGMANN
ALL INFORMATION IS PROPRIETARY AND NOT TO BE DUPLICATED