

FRONT VIEW

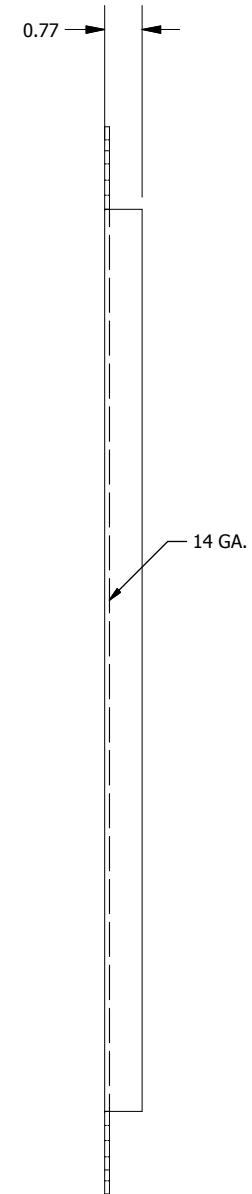

SIDE VIEW

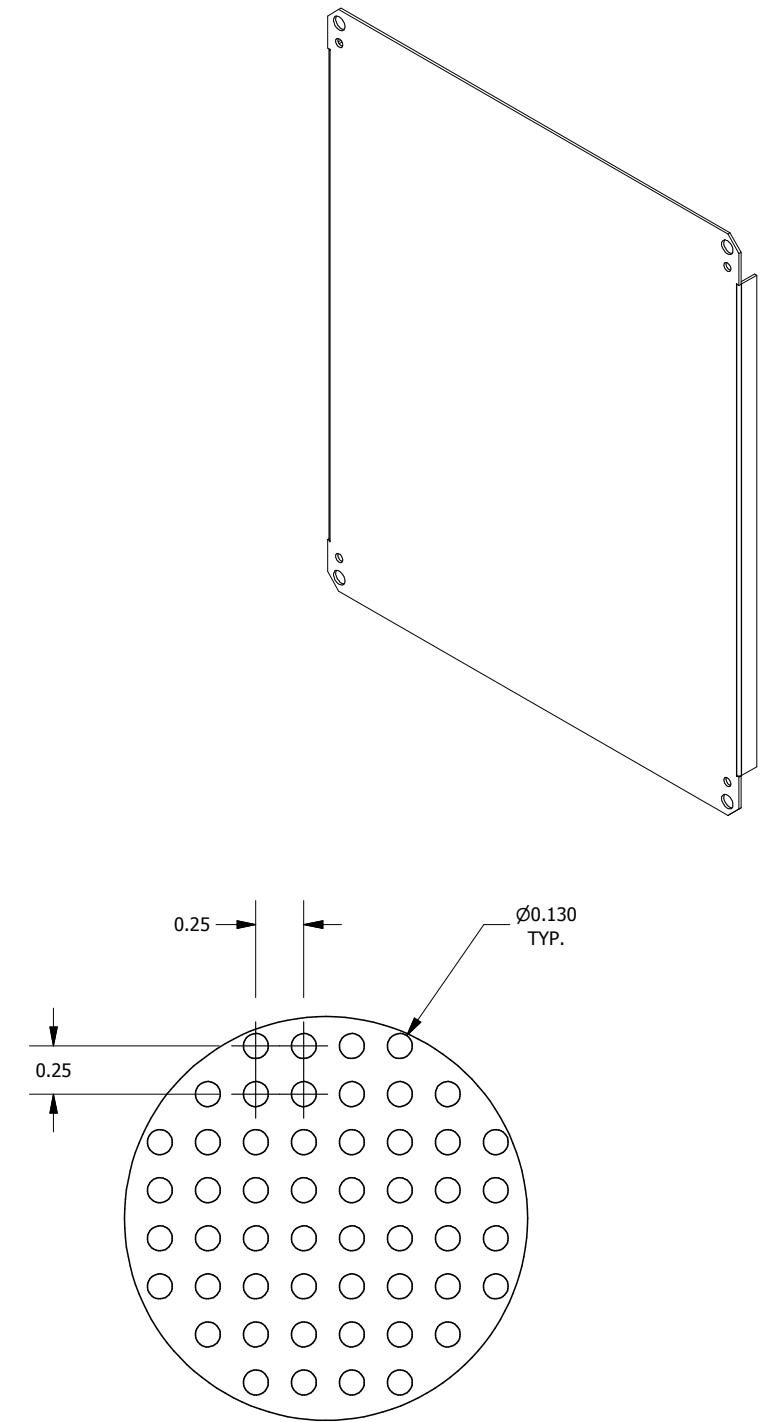

**DETAIL-A
(PERFORATED DETAIL)**

PART#: NP2420CPP
 (DATA SUBJECT TO CHANGE WITHOUT NOTICE)

THIS DRAWING IS PROPERTY OF HUBBELL INC. WIEGMANN
 ALL INFORMATION IS PROPRIETARY AND NOT TO BE DUPLICATED