

**FRONT VIEW**

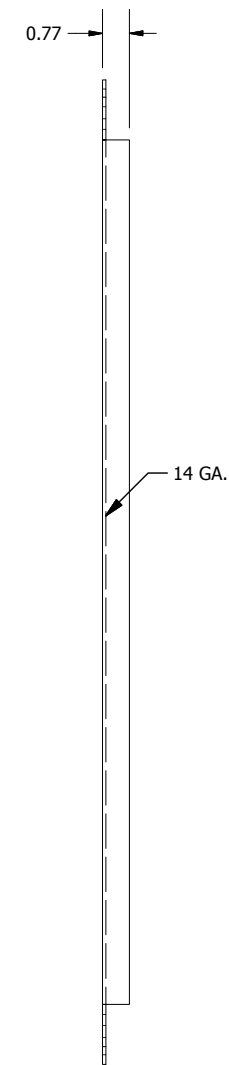

**SIDE VIEW**

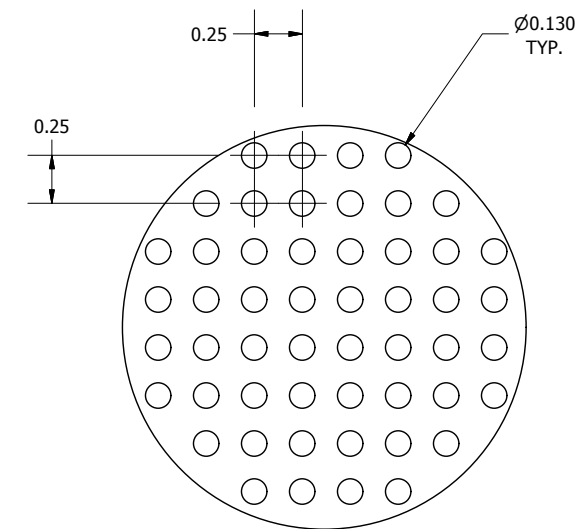
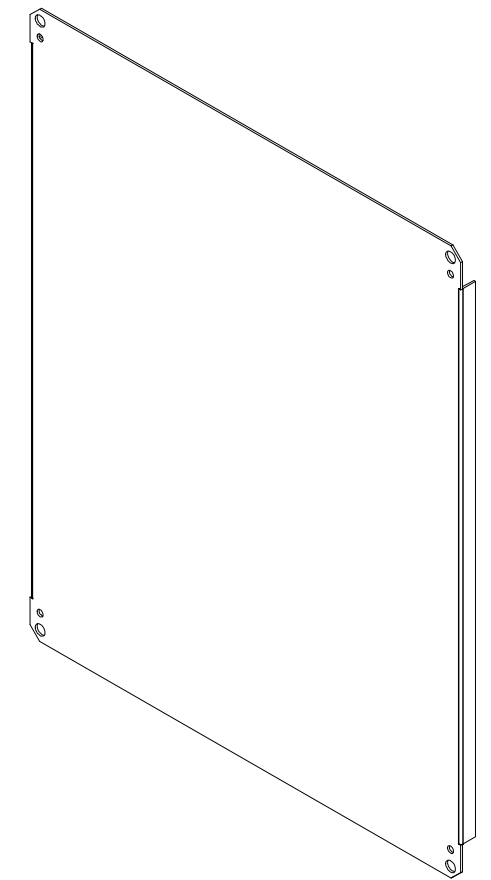

**DETAIL-A  
(PERFORATED DETAIL)**

PART#: NP3024CPP  
(DATA SUBJECT TO CHANGE WITHOUT NOTICE)

THIS DRAWING IS PROPERTY OF HUBBELL INC. WIEGMANN  
ALL INFORMATION IS PROPRIETARY AND NOT TO BE DUPLICATED