

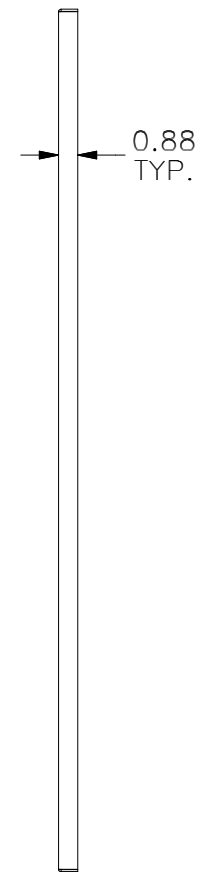

PART#: NP4224
(DATA SUBJECT TO CHANGE WITHOUT NOTICE)

THIS DRAWING IS PROPERTY OF HUBBELL INC. WIEGMANN
 ALL INFORMATION IS PROPRIETARY AND NOT TO BE DUPLICATED

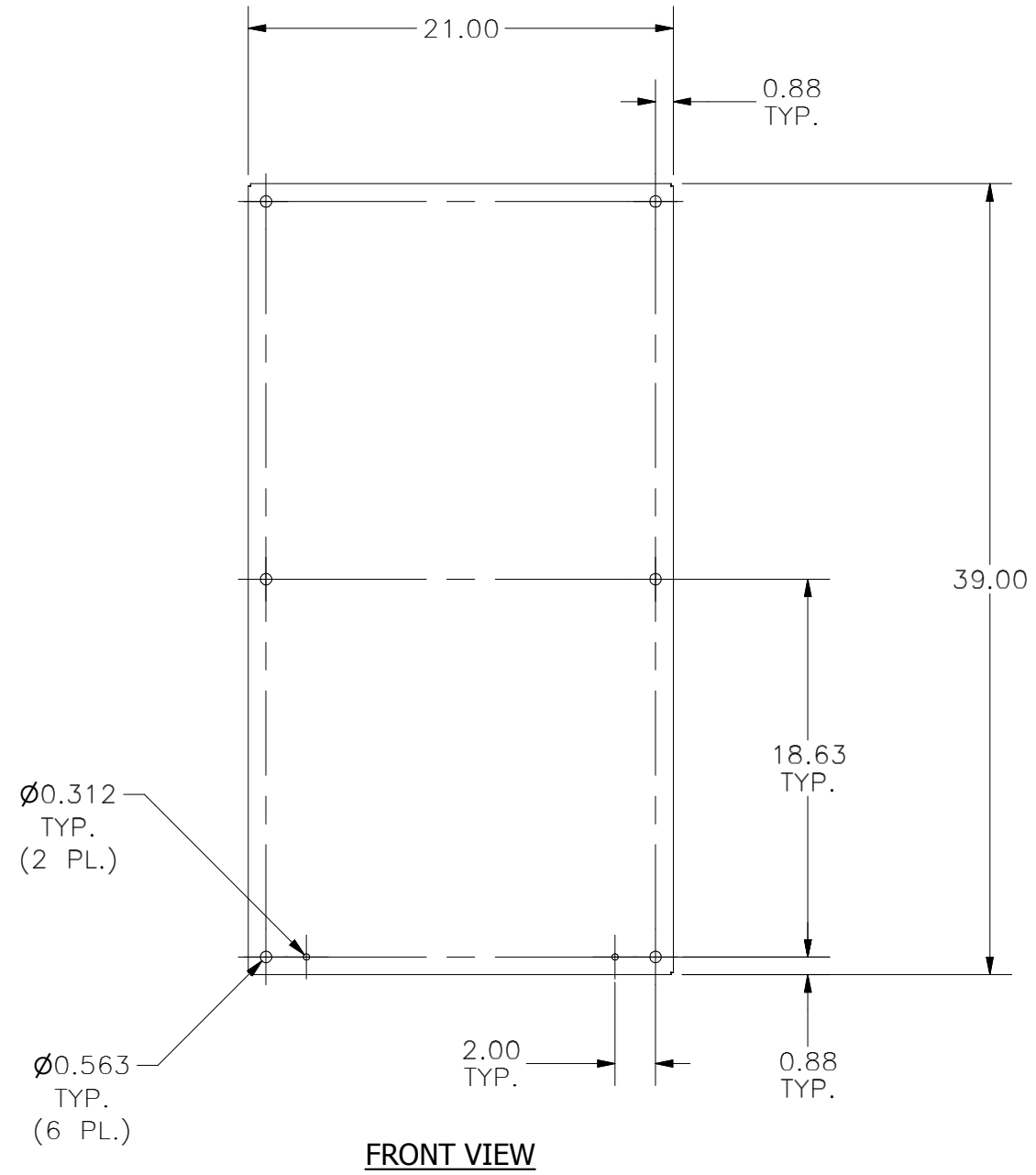

SIDE VIEW

