

FRONT VIEW

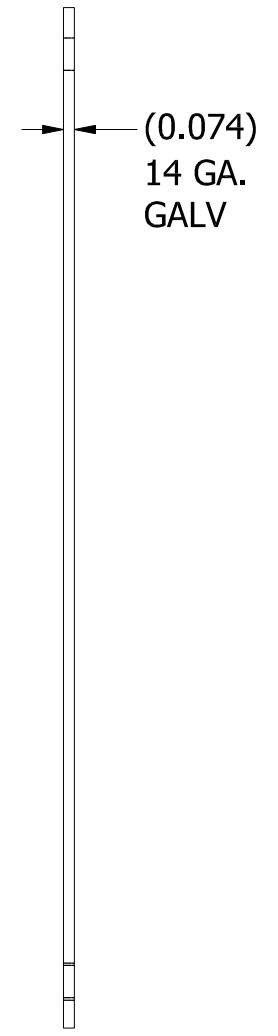

SIDE VIEW

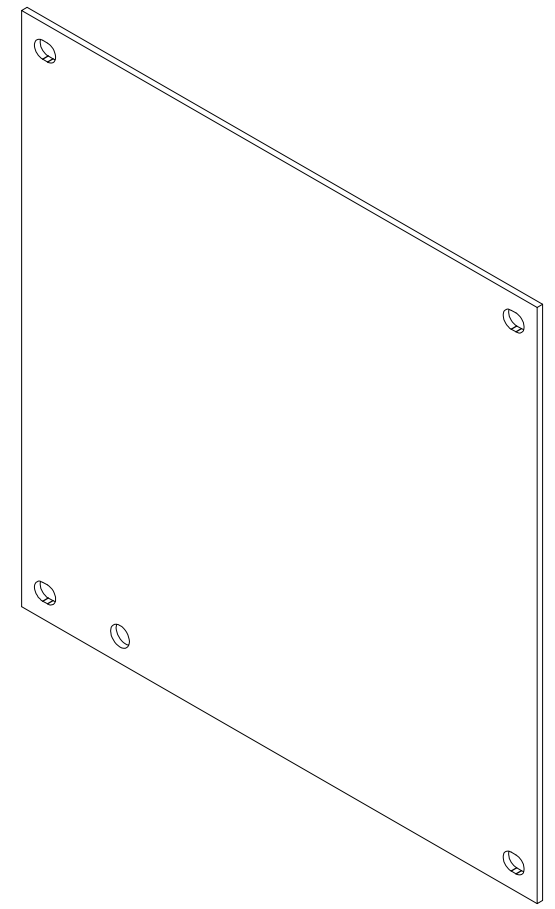

PART#: P0808G
 (DATA SUBJECT TO CHANGE WITHOUT NOTICE)
 THIS DRAWING AND COMPONENTS OF ARE PROPERTY OF HUBBELL INC. WIEGMANN