

TOP VIEW

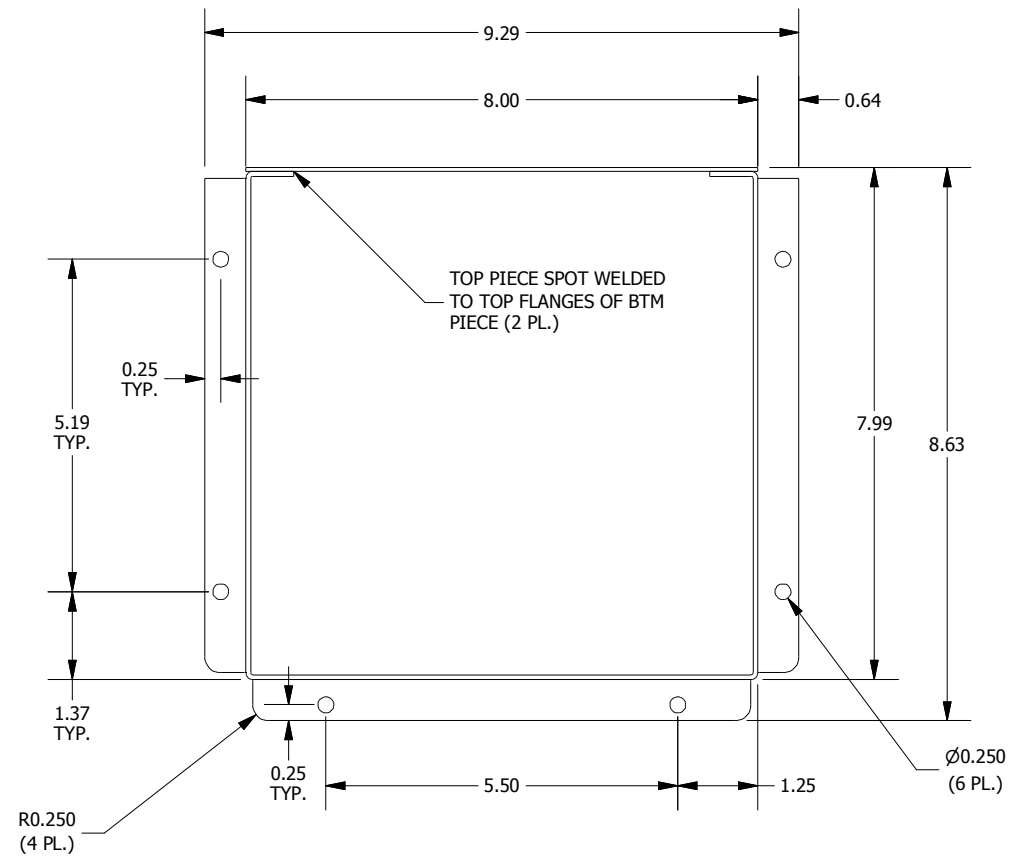

FRONT VIEW

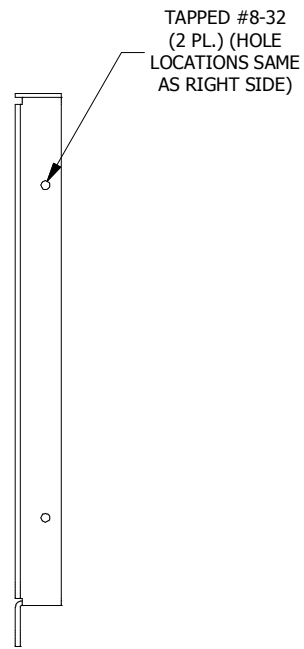

LEFT SIDE VIEW

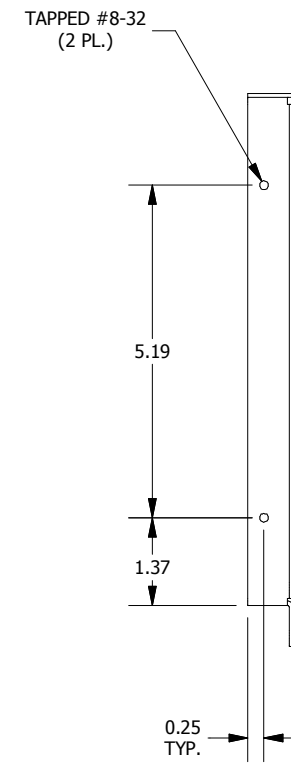

RIGHT SIDE VIEW

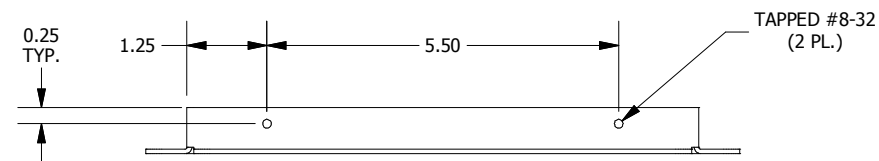
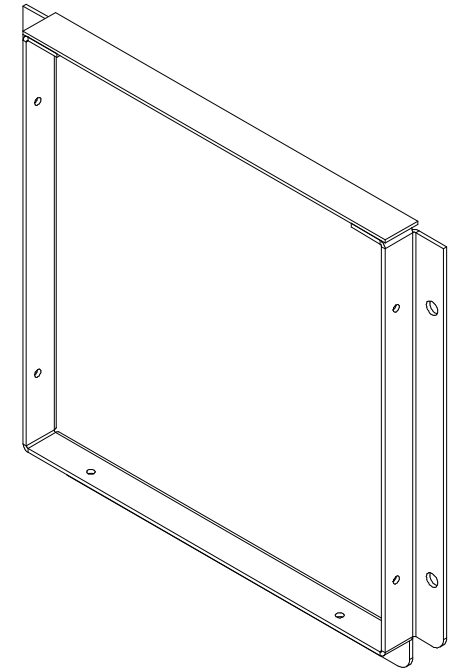

BOTTOM VIEW

PART#: PA0808G
 (DATA SUBJECT TO CHANGE WITHOUT NOTICE)

THIS DRAWING IS PROPERTY OF HUBBELL INC. WIEGMANN
 ALL INFORMATION IS PROPRIETARY AND NOT TO BE DUPLICATED